



CODONICS[®]

We bring the future into focus

Horizon[®] ***Multi-media*** ***Dry Imager***

User's Manual

Codonics[®] Catalog Number HORIZON MNLU

July 07, 2022

Version 3.1.1 USB Flash Drive

Version 2.2.1 ZIP Disk

Codonics, Inc.

17991 Englewood Drive

Middleburg Heights, OH 44130 USA

440.243.1198 Phone

440.243.1334 Fax

Email info@codonics.com

www.codonics.com

Copyright © 2004 – 2022 by Codonics, Inc. All rights reserved, worldwide.
Printed in the U.S.A. Part Number 905-019-105.

No part of this document may be copied or reproduced in any form by any means without prior written consent of Codonics, Inc., 17991 Englewood Dr., Middleburg Heights, Ohio 44130 U.S.A.

Although every effort has been made to ensure the accuracy of this document, Codonics, Inc. assumes no responsibility for any errors that may appear. Codonics, Inc. makes no commitment to update nor to keep current the information contained in this document.

Horizon Patents: www.codonics.com/ip/patents

Horizon, DirectVista, ChromaVista, the Codonics logo, and “We bring the future into focus” are registered trademarks, and Codonics, Variable Multiformating, VMF, Fixed Multiformating, FMF, Medical Color Matching, MCM, SlideMaker, and Bracketing are trademarks of Codonics, Inc.

Windows and Windows NT are registered trademarks of Microsoft Corporation.

PostScript is a registered trademark of Adobe Systems Incorporated.

Apple and Macintosh are trademarks of Apple Computer, Inc., registered in the U.S. and other countries.

UNIX is a registered trademark of The Open Group.

Linux is a registered trademark of Linus Torvalds.

Zip is a registered trademark of Iomega Corporation.

StuffIt is a trademark of Aladdin Systems, Inc.

PKZIP is a registered trademark of PKWARE, Inc.

Intel is a registered trademark of Intel Corporation or its subsidiaries in the United States and other countries.

All other registered and unregistered trademarks are the property of their respective owners.



CAUTION Approved FDA Class 2 device - Federal law restricts this device to be sold for use by or on the order of a physician.

European Authorized Representative:

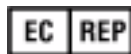

CEpartner4U BV
Esdoornlaan 13,
3951 DB Maarn
The Netherlands
www.cepartner4u.com



Contents

Contents

Preface

Conventions Used in This Manual.....	xi
Bulleted Lists.....	xi
Numbered Steps.....	xi
Control Panel Navigation.....	xii
Control Panel Keys.....	xii
Control Panel Menu Options.....	xii
Notes and Tips.....	xii
Cautions and Warnings.....	xiii
Text Files and Displayed Text.....	xiii
User Data.....	xiii
Important Information and Filenames.....	xiv
New Terms.....	xiv
Purpose and Scope.....	xv
Product Information.....	xvi
Warnings and Limitations of Use.....	xvii
Location of Safety and Compliance Labels.....	xvii
Voltage Warning.....	xviii
Dangers Electriques.....	xix
Laser Warning.....	xxi
Dangers au Laser.....	xxii
Temperature Warning.....	xxiii
Dangers Température.....	xxiii
Compliance.....	xxiv
Serial Number, Configuration and Modification Codes.....	xxv
ESD Caution.....	xxvi

Potential for Radio Frequency Interference on Imager Operation	xxvi
Potential for Radio and Television Interference	xxvii
Guidance Regarding Electromagnetic Emissions and Immunity	xxviii
Safety Precautions	xxx
Précaution d'Emploi	xxxiii
Location Precautions.....	xxxv
Environnement de Fonctionnement	xxxvi
Cleaning Precautions	xxxvii
Précautions d'Entretien	xxxviii
Media	xxxviii
Codonics Paper/White Film Media.....	xxxix
File Transfer via FTP and LPR.....	xl
Color Management.....	xl
Image Scaling	xli
Hardware Variations.....	xli
Disposal Requirements	xlii
Conditions et Règles d'Utilisation.....	xlii
European Disposal Requirements	xlii
Indications for Use	xliii

Chapter 1: Introduction

Welcome and Congratulations	1-1
Imager Features	1-2
State-of-the-Art Printing Technology	1-2
Small Footprint	1-2
Wide Variety of Media Types and Sizes	1-3
Easy Access from a Variety of Image Sources	1-3
Support for Major Image File Formats	1-4
Image Formatting and Enhancement Capabilities	1-5
Adding Captions to Printed Sheets	1-5
Easy Feature Upgrade	1-5
Easy Imager Personality Swap	1-6
Easy Software Updates and Configuration Backups	1-6

Chapter 2: Setting Up the Imager

Preparing for Installation.....	2-1
Installing the Imager	2-2
Connecting the Ethernet Cable	2-8
Powering On the Imager—First Time	2-10
Cleaning the Platen.....	2-11
Network Settings—Simple Network.....	2-12
Specifying the Imager’s IP Address	2-13
Determining an IP Address.....	2-13
Specifying the Imager’s IP Address at the Control Panel.....	2-14
Specifying IP Addresses for Other Devices on the Network	2-17
Loading Media	2-17
Printing the Imager Status Test Print.....	2-18
Testing Network Printing	2-19
Changing the Service Password	2-20
Adjusting Image Appearance	2-20
Saving the Configuration Settings	2-20
Saving the Configuration Settings to Backup Media	2-21
Managing Your Backup Media	2-23
Restoring the Configuration Settings from Backup Media	2-24
Moving Smart Card to a Swap Imager.....	2-25
Preparing the Imager for Shipment	2-26

Chapter 3: Basic Imager Operations

Horizon Imager Components.....	3-1
Powering the Imager On and Off.....	3-3
Powering On the Imager	3-3
Observing the Imager’s Operating Status in the Status Screen.....	3-4
Common Cassette Status Messages	3-5
Color Ribbon Status.....	3-6
Powering Off the Imager	3-7
Rebooting the Imager.....	3-9
Understanding the Control Panel	3-10
Control Panel Indicators.....	3-11

Alert and Fault Messages and the Fault Tone	3-12
Control Panel Display.....	3-13
Status Screen	3-13
Main Menu	3-14
Control Panel Keys	3-16
Navigating the Control Panel Display.....	3-18
Cancelling Your Changes in a Screen.....	3-21
Exiting the Menus	3-21
Summary of Menu Conventions.....	3-21
The Pause State.....	3-22
Pausing the Imager	3-22
Resuming Printing.....	3-23
Using Online Help.....	3-23

Chapter 4: Media Handling and Storage

Overview.....	4-1
Supply Slots and Cassettes	4-1
Viewing the Status of a Supply Slot.....	4-3
Receive Trays	4-3
Inserting or Changing Cassettes	4-4
Determining Which Cassette to Use.....	4-6
Handling and Storing Media	4-7
Break-Off Leaders (ChromaVista Only)	4-7
Changing the Ribbon (ChromaVista).....	4-8
Ordering Media.....	4-12

Chapter 5: Printing from DICOM Applications

Introduction to DICOM.....	5-1
DICOM Conformance Statement	5-2
How a DICOM Print Job Is Processed.....	5-3
Configuring the DICOM Application.....	5-4
Sending a DICOM Print Job	5-5
Specifying the Media Type and Size	5-5
Using Job Settings Files with DICOM.....	5-6

Categories of Job Settings	5-6
Specifying a Job Settings File from a DICOM User Application.....	5-7
Hierarchy of Settings Used by the Horizon Imager	5-8

Chapter 6: Printing via PostScript

Introduction to PostScript	6-2
Hierarchy of Parameter Settings Used by the Horizon Imager	6-3
Specifying the Media Type and Size	6-3
Printing from Windows Applications	6-4
Specifying Horizon PostScript Parameters	6-4
Notes About Changing PostScript Parameters.....	6-5
Changing Horizon PostScript Parameters—Windows 98 and Me.	6-9
Changing Horizon PostScript Parameters—Windows NT	6-12
Changing Horizon PostScript Parameters—Windows 2000 and XP ...	6-15
Printing from Macintosh Applications.....	6-16
Specifying the Horizon Media	6-16
Specifying Horizon PostScript Parameters	6-18
Notes About Changing PostScript Parameters.....	6-20
Saving Horizon Print Settings as Presets in OS X	6-24
Saving Horizon Print Settings in OS 8 and 9	6-24

Chapter 7: Printing via FTP and LPR

Printing via FTP	7-1
Specifying the Media Type and Size Using FTP	7-4
Printing via LPR.....	7-5
Examples of Printing Using LPR.....	7-6
Specifying the Media Type and Size Using LPR.....	7-6

Chapter 8: Default Print Job Settings

Changing Default Settings.....	8-2
Changing the Default Media Type and Size.....	8-3
Changing Default User Settings for a Media Type.....	8-5

Resetting to Factory-Default Settings	8-7
Resetting the Default Media Selections	8-7
Resetting the Default User Settings	8-8

Chapter 9: Adjusting Image Appearance

ChromaVista and Grayscale Images	9-1
Guidelines for Viewing Printed Images	9-2
General Bracketing Guidelines	9-2
GCS Bracketing Sheets	9-3
Printing GCS Bracketing Sheets Using DICOM	9-4
Printing GCS Bracketing Sheets Using PostScript	9-5
DirectVista Adjustments	9-5
ChromaVista Adjustments	9-7
Guidelines for Selecting Saturation Setting	9-8
MCM Bracketing Sheets	9-9
Printing MCM Bracketing Sheets Using DICOM	9-11
Printing MCM Bracketing Sheets Using PostScript	9-11

Chapter 10: Preventive Maintenance

Recommended Maintenance Schedule	10-1
Horizon Cleaning Kits	10-2
Cleaning Print Head and Nosepiece	10-3
Cleaning the Platen and Donor Guide Bar	10-8
Cleaning the Pick Tires	10-13
Cleaning the Barcode Reader Window	10-15
General Cleaning Procedures	10-18
Cleaning the Area Around the Imager	10-18
Cleaning the Receive Trays	10-18
Cleaning the Basement	10-19

Chapter 11: Calibration

Film Calibration (DirectVista Film Only)	11-2
--	------

Chapter 12: Troubleshooting

Sources of Status Information	12-1
Control Panel	12-1
Error Log	12-1
Online Help for Displayed Messages	12-1
Printing an Imager Status Test Print	12-2
Troubleshooting Tables	12-2
Status Message Tables	12-12
Common Cassette Status Messages	12-12
Color Ribbon Status	12-13
Clearing a Sheet Jam	12-14
Clearing a Jam from a Cassette	12-16
Clearing a Jam from the Printing Area	12-19
Reinstalling Media Guides	12-22
Purging Print Jobs	12-25
Manually Entering a Cassette Barcode	12-26
Viewing Logged Error Messages	12-28
Viewing Imager Information Online	12-29
Contacting Technical Support	12-30
Anonymous FTP	12-31

Chapter A: Menu Hierarchy

Chapter B: Specifications

Specifications (English)	B-1
Specifications (French)	B-4

Chapter C: System Job Settings Files

Chapter D: Print Job Parameters

Chapter : Index

Preface

Conventions Used in This Manual

Bulleted Lists

Bullets are used to display a list of nonprocedural items. For example:

The control panel contains:

- A display panel
- Keys
- Indicators

Numbered Steps



The  icon indicates the beginning of a procedure. The steps in a procedure are numbered. For example:



To access the Main Menu and scroll through menu options

1. Press the  key.

The Main Menu displays on the control panel. The selector arrow () automatically points to the first menu option.

2. To scroll through the menu options, press the  and  keys.

The selector arrow () moves up and down through the list. The bottom portion of the control panel display shows a message associated with the currently selected menu option.

Control Panel Navigation

Menu paths are used in some procedures instead of documenting every step needed to navigate to a specific menu option. For example:

From the Main Menu, select the following options:

Default Media
Grayscale
DV Film Blue

Control Panel Keys

Control panel keys are shown in small black ovals to resemble the actual keys, for example, “Press the  key.”

Control Panel Menu Options

Control panel menu options are shown in bold type, for example, “Select the **Gamma** menu option.”

Notes and Tips

Notes contain additional information related to a topic or procedure. For example:



NOTE: *If your network is managed by a network administrator or an information technology (IT) department, it would be considered a complex network. You should have the responsible person perform any network-related administrative tasks.*

Tips provide additional insights about a topic or procedure (such as, why you may want to do something or a faster way to perform an operation). For example:



TIP: Specifying print settings in a multi-user environment

If the Horizon imager is accessed by multiple users, it is typically better for individual users to enter print values through the DICOM application interface rather than change the default settings through the control panel.

Cautions and Warnings

Cautions alert you to actions or situations that could cause harm to equipment or data. For example:



CAUTION Any changes you make to the imager default settings will also affect prints made by other users. Use caution when changing default settings.

Warnings alert you to actions or situations that could result in personal injury. For example:



WARNING With the imager cover open, touch only those internal components that are colored green.

Text Files and Displayed Text

Monospaced `type` is used for the contents of an ASCII file or machine text displayed in a terminal command window.

User Data

Bold monospaced type is used to indicate specific characters or words that you enter at a host workstation when performing advanced imager operations. *If the type is also italicized*, it indicates variable text. For example:



To query
imager status
using Telnet

1. From your workstation, open a UNIX or MS-DOS command window.
2. Enter the command `telnet hostname` OR `telnet IP Address` (using either the Horizon imager hostname or IP Address).
3. At the login prompt, enter the command `status`.

Important Information and Filenames

Bold type is used for emphasis, command names, and paths or filenames. For example:

- The Horizon imager default settings can be changed both at the control panel and using text files.
- The hostname and IP Address must be added to the **/etc/hosts** file.

New Terms

Italic type is used when a term is introduced and defined. For example:

- The Horizon imager has a complete set of *default settings* that contain preconfigured values for every aspect of a printed sheet.

Purpose and Scope

Refer to this user manual for procedures on how to perform the most common imager operations, including:

- Setting up the imager
- Loading media
- Sending print jobs from DICOM Print Service Class-compliant applications running on imaging devices or image viewing workstation
- Sending print jobs from workstations via PostScript
- Sending print jobs using FTP and LPR
- Changing the imager's default image and sheet settings
- Adjusting the appearance of printed images for user preference
- Performing preventive maintenance
- Performing film calibration
- Troubleshooting common problems



NOTE: Some features and functions described here may not apply to older versions of the software.

This User's Manual is intended to be as simple and straightforward as possible for the everyday user. If you need more detailed or more technical information on a feature or topic, or wish to perform more advanced operations, refer to the *Horizon Imager Technical Manual* (Catalog no. HORIZON MNLT). The Technical Manual serves as a companion document to this manual

Product Information

For technical assistance with the Horizon, call Codonics Technical Support at the following number:

Phone: +1.440.243.1198
Toll Free: 800.444.1198 (USA only)

Technical Support is available anytime. Technical Support is also available online via email and the Codonics web site:

Email: support@codonics.com
Web Site: www.codonics.com

General product information can also be requested by sending email to:

Email: info@codonics.com

Please include your postal mailing address and telephone number in the email message. Basic product information is returned via email unless otherwise requested.

Warnings and Limitations of Use

Location of Safety and Compliance Labels

The following figure shows the locations of the imager's safety and compliance labels.

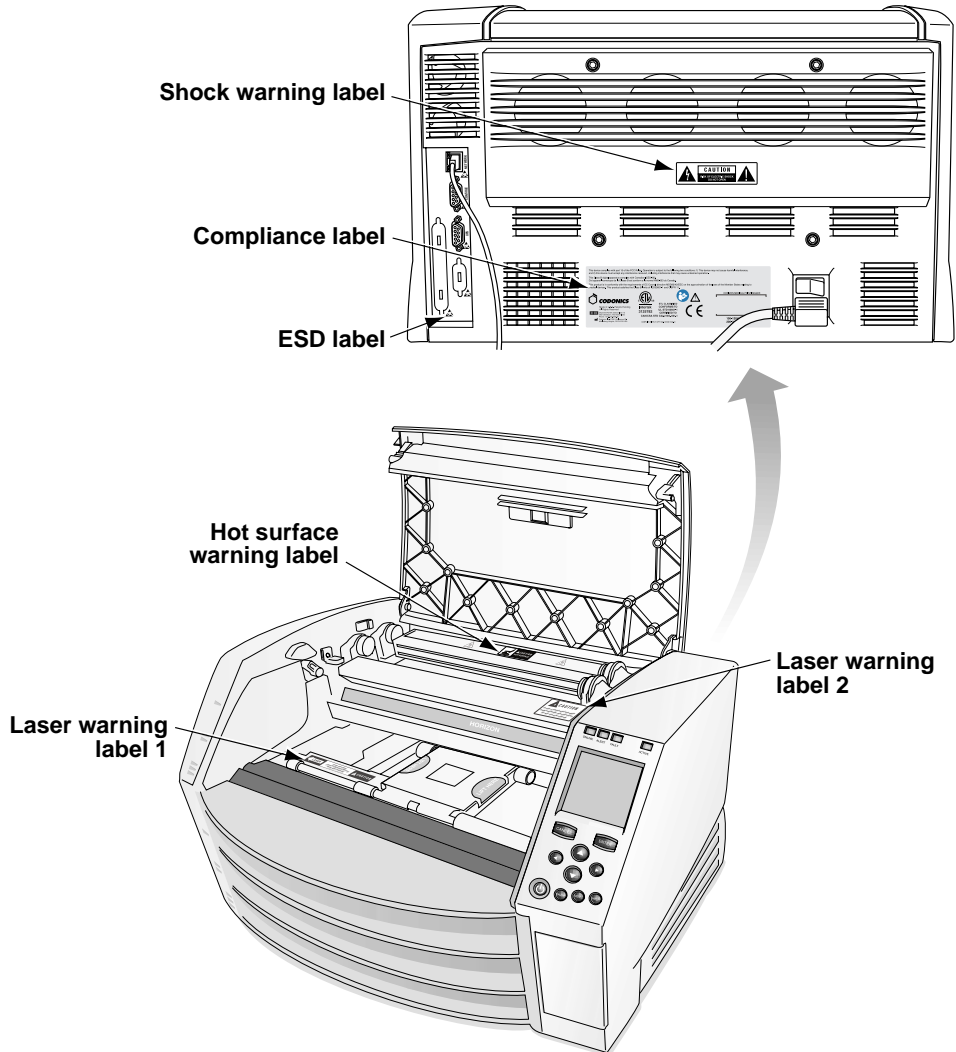

Voltage Warning

The exclamation point within an equilateral triangle and person reading a manual symbol are intended to alert the user to the presence of important operating and maintenance (servicing) instructions in the literature accompanying this device.



NO USER-SERVICEABLE PARTS INSIDE. REFER SERVICING TO QUALIFIED SERVICE PERSONNEL. REMOVAL OF LABELS, COVERS, OR ENCASMENT FASTENERS VOIDS THE WARRANTY.

THIS APPARATUS MUST BE ELECTRICALLY GROUNDED.

TO PREVENT FIRE OR SHOCK HAZARD, DO NOT EXPOSE THIS IMAGER TO RAIN OR MOISTURE.

EQUIPMENT IS NOT TO BE USED AS A COMPONENT OF A LIFE SUPPORT SYSTEM. Life support devices or systems are devices or systems that support or sustain life, and whose failure to perform can be reasonably expected to result in a significant injury or death to a person. A critical component is any component of a life support device or system whose failure to perform can be reasonably expected to cause the failure of the life support device or system, or to affect its safety or effectiveness.



WARNING Grounding reliability can be achieved only when the Horizon is connected to a receptacle marked “Hospital Only” (that is, “Hospital Grade”).



WARNING The power cord connected to the Horizon is the main disconnect for the system.



WARNING To disconnect overall power to the Horizon prior to servicing it, power off the system (refer to “Powering Off the Imager” on page 3-7).



WARNING Do not modify this equipment without authorization of the manufacturer



WARNING External equipment intended for connection to signal input, signal output, or other connectors, shall comply with relevant IEC standard (e.g., IEC 60950 for IT equipment and the IEC 60601 series for medical equipment). In addition, all such combinations - systems - shall comply with the IEC 60601-1-2 standard for Medical Electrical Equipment Systems. Equipment not complying to IEC 60601 shall be kept outside the patient environment, as defined in the standard. Any person who connects external equipment to signal input, signal output, or other connectors has formed a system and is therefore responsible for the system to comply with the requirements of IEC 60601-1-2. If in doubt, contact a qualified technician or Codonics Technical Support for approved configurations.



WARNING Do not touch a patient while also accessing the internal components that are under the top cover or receive trays.

Dangers Electriques

Le point d'exclamation dans un symbole triangle et la personne qui lit un symbole manuel visent à alerter l'utilisateur de la présence d'importantes instructions d'utilisation et de maintenance (entretien) dans la documentation qui accompagne cet appareil.



AUCUNE PIECE N'EST REPARABLE PAR L'UTILISATEUR. POUR SOUTIEN ADRESSEZ-VOUS AU PERSONNEL QUALIFIE. LE RETRAIT DE LES ETIQUETTES, LES COUVERTURES, OU LES ATTACHES PEUT ANNULENT LA GARANTIE.

CET APPAREIL DOIT ETRE ELECTRIQUEMENT RELIE A LA TERRE.

N'EXPOSEZ PAS CET APPAREIL À LA PLUIE OU L'HUMIDITÉ, EN RAISON DU RISQUE DE FEU OU DE DÉCHARGES ÉLECTRIQUES.

CET APPAREIL NE DOIT PAS ÊTRE UTILISÉ COMME COMPOSANT D'UN SYSTÈME D'ASSISTANCE VITALE. Les devis ou les systèmes vitale sont quelque devis ou système qui assistent ou soutiennent la vie, et si les devis ou systèmes échouent, on peut attendre raisonnablement la mort ou la blessure. Cet appareil ne doit pas être utilisé dans des conditions où la défaillance de l'appareil pourrait entraîner la blessure ou la mort de quelqu'un.



ATTENTION Une mise à la terre fiable est possible seulement pendant que le Horizon est connecté aux appareils marqué "Hospital Only" (de qualité hospitalière).



ATTENTION Le fil électrique connecté à le Horizon est le système de coupure principal de l'appareil.



ATTENTION Pour débrancher le fil électrique avant le soutien, se déconnecter et puis éteint le système (renvoyer à " Powering Off the Imager " sur la page 3-7).



ATTENTION Ne modifiez pas cet équipement sans l'autorisation du fabricant.



ATTENTION Toute équipement externe qui serait connecté vers le signal d'entrée ou de sortie ou autre connecteur, doit être compatible avec la norme IEC standard (IEC 60950 pour les équipements IT et IEC 60601 pour les équipements médicaux). Toutes les combinaisons de systèmes doivent être compatible avec IEC60601-1-2 standard, sécurité requise pour les équipements électriques médicaux. Tout équipement non compatible avec IEC 60601 doit être mis a l'écart de l'environnement patient, comme définis dans le standard. Toute personne qui connecte un équipement externe vers une entrée signal, ou sortie signal ou autres connecteur, est responsable de la compatibilité avec IEC 60601-1-2. Si vous avez un doute, contactez un technicien qualifié ou le support technique de Codonics pour l'approbation des configurations.



ATTENTION Ne pas touchez un patient lors d'un accès aux composants internes qui sont sous le capot supérieur ou les bacs de sortie.

Laser Warning

The Horizon imager uses a laser to read barcode information on the media cassettes. The laser module is a 650 – 670-nm device of 1.26 mW or less. As such it has been found to comply with the 21 CFR 1040.10 and 1040.11 and IEC 60825 laser standards as a low power Class 1 device.

For safety reasons, the laser is turned on only for a short time when a cassette is inserted. Still, one should use caution and never stare at the laser beam, should avoid exposure to the laser, and should never override any of the interlocks and safety mechanisms. These measures are taken for your protection.



WARNING Use of controls or adjustments to the performance of procedures other than those specified in this manual may result in hazardous radiation exposure.

The laser apertures are marked with a single label, shown below. There are three apertures that correspond to the three cassette locations, one for each, on the same side of the Horizon imager as this label.



Safety interlocks are marked by the following label. They are located on the same side of the Horizon imager as this label.

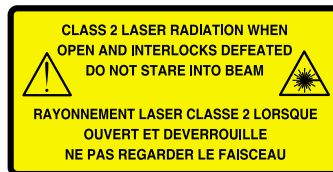

The locations of the two laser labels are shown in the figure on page xvii.

Dangers au Laser

L'imageur Horizon utilise un laser pour lire les informations de codes à barres sur les cassettes des médias. Le module laser est un appareil 650 à 670 nm de 1,26 MW ou moins. Comme tel, il a été jugé conforme à la norme CFR 21 1040.10 et 1040.11 et les normes IEC 60825 comme un laser de classe 1 de faible puissance appareil.

Pour des raisons de sécurité, le laser est activé uniquement pour une courte durée quand une cassette est insérée. Pourtant, on devrait faire attention et de ne jamais regarder le faisceau laser; devrait éviter l'exposition au laser, et ne doit jamais remplacer l'un des verrouillages et des mécanismes de sécurité. Ces mesures sont prises pour votre protection.



ATTENTION L'utilisation de commandes ou de réglages à l'exécution de procédures autres que celles spécifiées dans ce manuel peut entraîner une exposition à des radiations dangereuses.

Les ouvertures laser sont marqués d'une étiquette unique, illustré ci-dessous. Il ya trois ouvertures qui correspondent aux trois endroits cassette, une pour chacun, sur le même côté de l'imageur Horizon que cette étiquette.



Verrouillages de sécurité sont marqués par l'étiquette suivante. Ils sont situés sur le même côté de l'imageur Horizon que cette étiquette.

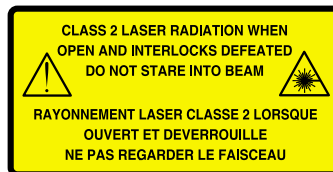

Les emplacements des deux étiquettes laser sont présentés dans la figure sur page xvii.

Temperature Warning

Because the Horizon imager is a thermal print device, the surface of the thermal print head heat sink gets hot. Avoid directly touching any components not colored green when accessing the interior of the imager if the imager has been printing. (During some preventative maintenance tasks, you will be touching internal components with cleaning pads or swabs.)

The temperature warning label is shown below.



Dangers Température

Parce que l'imager Horizon est un appareil d'impression thermique, la surface du dissipateur de chaleur de tête d'impression thermique est chaude. Évitez de toucher directement des composants non colorés en vert lors de l'accès à l'intérieur de l'imager, si l'imager a été en usage. (Au cours de certaines tâches d'entretien préventif, vous serez toucher les composants internes avec des tampons de nettoyage ou de tampons.)

L'étiquette d'avertissement de température est indiqué ci-dessous.



Compliance

Codonics is in compliance with various regulations, of which details are listed in Appendix B.

The Compliance label, which is affixed at the back of the imager, is shown below.

This device complies with part 15 of the FCC Rules. Operation is subject to the following two conditions: 1) This device may not cause harmful interference, and 2) this device must accept any interference received, including interference that may cause undesired operation.

This Class A digital apparatus complies with Canadian ICES-003.
Cet appareil numérique de la Classe A est conforme à la norme NMB-003 du Canada.



This product is in conformity with the requirements of MDR 2017/745/EU on the approximation of the laws of the Member States relating to medical devices. This product satisfies the Class A limits of IEC 60601-1-2 for Professional Healthcare Facilities and CISPR 11.

 **CODONICS**
Made in U.S.A.
Patents:
www.codonics.com/ip/patents/
All Rights Reserved

 **CE** REP
CEpartner4U BV, Eesdoornlaan 13
3951 DB Maarn, The Netherlands
www.cepartner4u.com

 Codonics Inc., 17991 Englewood Dr.
Middleburg Heights, OH 44130 USA

 **TUV** mark
AAMI STD ES60601-1
CSA STD 60601-1
IEC 60601-1

HORIZON MEDICAL PRINT IMAGER

100-120V~, 6.0A, 47/63Hz
200-240V~, 3.0A, 47/63Hz

COMPLIES WITH 21 CFR 1040.10 AND 1040.11

Compliance label

Serial Number, Configuration and Modification Codes

The Serial number label is placed onto the Compliance label. It includes the following information.

- The serial number (SN), which uniquely identifies the unit.
- The Configuration number (CNFG), which details the build configuration.
- The modifications codes, which are to the right of the CNFG number and are a series of 20 numbers. When any of these numbers are blocked out, that identifies a modification that was made to the unit.

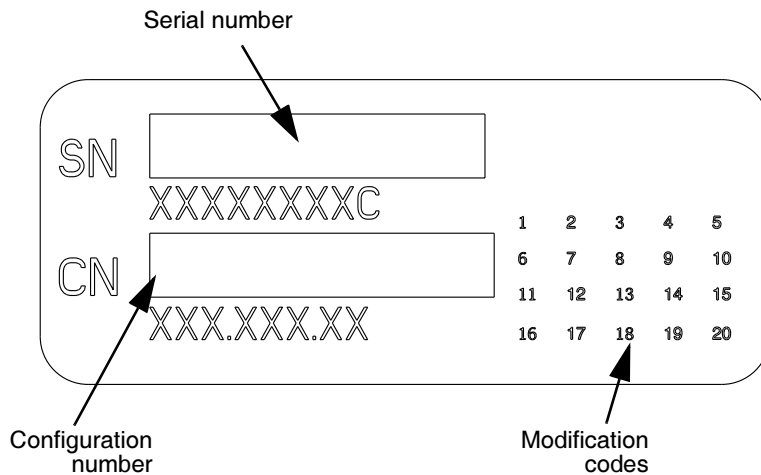

ESD Caution

Connections to other pieces of equipment are made at the rear of the Horizon imager. These connectors are marked with a precautionary ESD warning symbol, as shown below. Do not touch any of the pins of these connectors. When making connections to the imager, it is best done while the imager is plugged in but not powered on. ESD may cause erratic behavior of the imager when powered on. Should this occur, power to the imager may have to be cycled. It is recommended that all staff involved in making connections to the imager be aware of these ESD precautions.

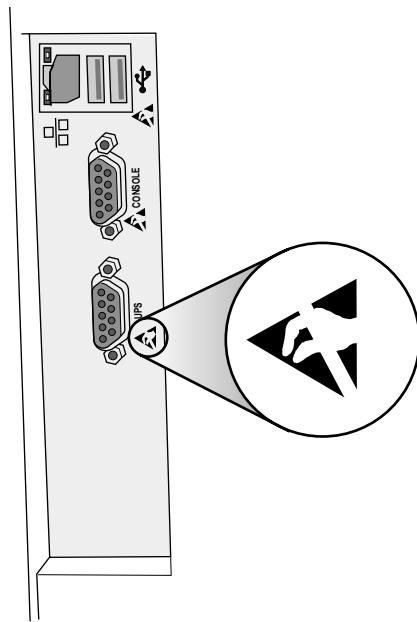

Rear panel

Potential for Radio Frequency Interference on Imager Operation

Both portable and mobile RF communications equipment can affect medical electrical equipment, including the Horizon imager. Keep such RF communications equipment out of the immediate area.

Potential for Radio and Television Interference

The Horizon imager generates and uses radio frequency energy, and if not installed and used properly, that is, in strict accordance with the manufacturer's instructions, may cause interference to radio and television reception. It has been type tested and found to comply with Class A emission limits for a computing device in accordance with the specifications in Subpart J of Part 15 of FCC Rules, which are designed to provide reasonable protection against such interference when operating in a commercial environment. Operation of the equipment in a residential area is likely to cause interference, in which case the user, at his own expense, will be required to take whatever measures may be appropriate to correct the interference. If your imager does cause interference to radio or television reception, you are encouraged to try to correct the interference by one or more of the following measures:

- Reorient the receiving antenna
- Relocate the imager with respect to the receiver

If necessary, you should consult Codonics technical support or an experienced radio/television technician for additional suggestions. You may find the following booklet prepared by the Federal Communications Commission helpful: *How to Identify and Resolve Radio-TV Interference Problems*. This booklet is available from the U.S. Government Printing Office, Washington, D.C. 20402, Stock No. 004-000-00345-4.

Le présent appareil numérique n'émet pas de bruits radio-électriques dépassant les limites applicables aux appareils numériques de la Classe A prescrites dans le Règlement sur le brouillage radioélectrique édicté par le ministère des Communications du Canada.

This product is in conformity with the requirements of EC Council regulation MDR 2017/745/EU on the approximation of the laws of the Member States relating to medical devices. This product satisfies the Class A limits of IEC60601-1-2 and CISPR 11. A declaration of conformity with the requirements of the regulation has been signed by the Director of Quality Assurance and Regulatory Affairs. Horizon is approved for export via FDA Certificates to Foreign Government and registered as a medical device for import. A current list of countries is available on request.

Guidance Regarding Electromagnetic Emissions and Immunity

Suitable Environments:

- Horizon is intended for use in professional healthcare facility environments, including hospitals and medical clinics.
- Horizon has not been evaluated for use near HF surgical equipment. If use near HF surgical equipment is desired, the user is responsible for verifying proper operation of the Horizon. If Horizon does not perform correctly in this environment, move the Horizon farther from the source of the electromagnetic disturbance.
- Horizon has not been evaluated for use in emergency medical vehicles.

As a support device, Horizon does not provide essential performance.



WARNING Use of this equipment adjacent to or stacked with other equipment should be avoided because it could result in improper operation. If such use is necessary, this equipment and the other equipment should be observed to verify that they are operating normally.



WARNING Use of accessories, transducers and cables other than those specified or provided by the manufacturer of this equipment could result in increased electromagnetic emissions or decreased electromagnetic immunity of this equipment and result in improper operation.



WARNING Portable RF communications equipment (including peripherals such as antenna cables and external antennas) should be used no closer than 30 cm (12 inches) to any part of the Horizon, its cables, or accessories. Otherwise, degradation of the performance of this equipment could result.

Electromagnetic Emissions Standards and Test Levels:

Test / Standard	Compliance Level
RF Emissions CISPR 11	Group 1, Class A
RF Emissions FCC Part 15	Class A
Conducted Emissions CISPR 11	Group 1, Class A
Harmonic Distortion IEC 61000-3-2	Class A
Voltage Fluctuations and Flicker IEC 61000-3-3	Complies

Electromagnetic Immunity Standards and Test Levels:

Test / Standard	Compliance Level
Electrostatic Discharge IEC 61000-4-2	±8kV contact ±2kV, ±4kV, ±8kV, ±15kV air

Electromagnetic Immunity Standards and Test Levels: (Continued)

Test / Standard	Compliance Level
Radiated RF Immunity	3 V/m
IEC 61000-4-3	80 MHz - 2.7 GHz 80 % AM at 1 kHz
Proximity fields from RF wireless equipment	Complies
IEC 61000-4-3	
Electrical Fast Transient / Burst	AC Port: ± 2 kV, 100 kHz repetition frequency
IEC 61000-4-4	SIP/SOP Ports: ± 1 kV, 100 kHz repetition frequency
Surge	Line-to-Line: ± 0.5 kV, ± 1.0 kV
IEC 61000-4-5	Line-to-Ground: ± 0.5 kV, ± 1.0 kV, ± 2.0 kV
Conducted Immunity	AC Port and SIP/SOPs:
IEC 61000-4-6	3V, 0.15 MHz - 80 MHz 6V, in ISM bands between 0.15 MHz and 80 MHz 80 % AM at 1 kHz
Magnetic Field Immunity	30 A/m, 50 Hz or 60 Hz
IEC 61000-4-8	
Voltage Dips	0% U_T , 0.5 cycle at 0°, 45°, 90°, 135°, 180°, 225°, 270° and 315°
IEC 61000-4-11	0% U_T , 1 cycle AND 70% U_T , 25/30 cycles, Single phase: at 0°
Voltage Interruptions	0% U_T , 250/300 cycle
IEC 61000-4-11	

Safety Precautions

- Never connect this imager to any outlet or power supply that has a voltage or frequency different than that specified on the rear of the imager.
- When servicing the imager, always power it off using the **⏻** (power) key at the control panel, then turn the rocker switch in the back to the **0** (off) position, then unplug the imager.
- Damage to the power cord may cause fire or shock hazard. When unplugging the power cord, hold it by the plug only and remove the plug carefully.
- If the power cord needs to be replaced, replace it only with another Codonics power cord manufactured specifically for your imager's power configuration.
- If the imager is smoking or making unusual sounds, power off and unplug the imager immediately.
- Do not insert foreign objects of any kind into the imager; doing so can constitute a safety hazard and cause extensive damage.
- Do not place any liquid containers on the imager. If, for some reason, liquid seeps into the imager, power off the imager and unplug the power cord from the source outlet. If used without corrective measures, the imager may be damaged.
- Do not use the imager near flammable gases.

- With the imager top cover open or the receive trays removed, touch only those internal components that are colored green (shown in the following figure). Remove rings, ties, jewelry, and other items, and tie back hair, so that they do not fall into or get caught in the imager.

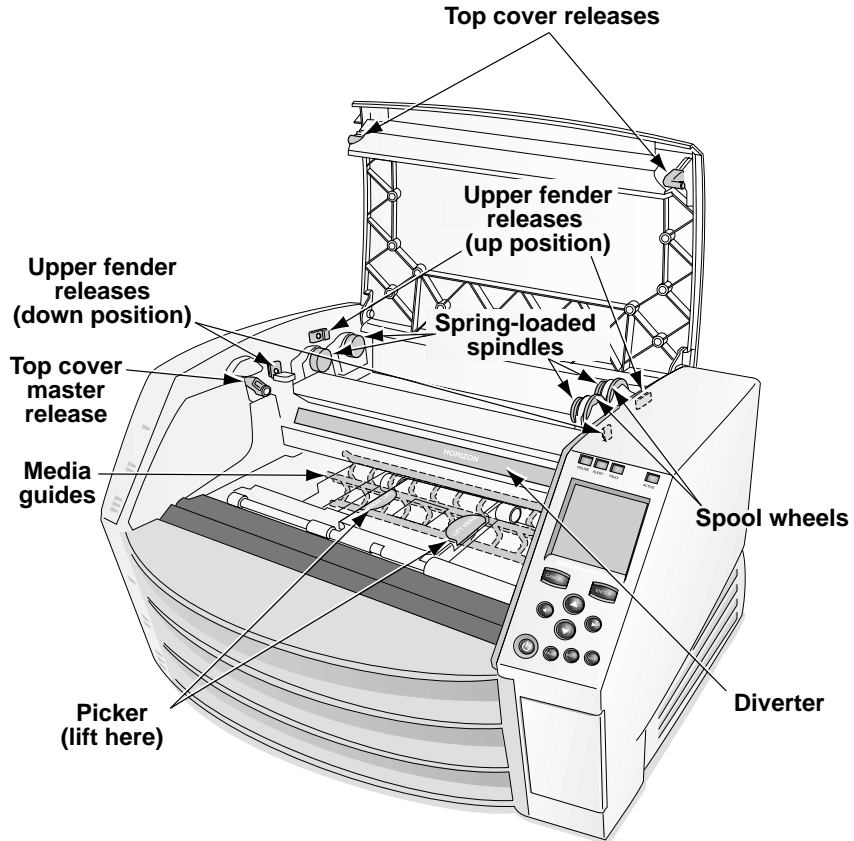

Internal Components That Are Colored Green (called out in the illustration) Are Safe to Touch

Précaution d'Emploi

- *Ne connectez jamais cet imageur à une prise ou d'alimentation qui a une tension ou une fréquence différente de celle indiquée à l'arrière de l'imageur.*
- *Lors de l'entretien de l'imageur, toujours l'éteindre à l'aide de la touche **⏻** (power) à partir du panneau de contrôle, puis tournez le commutateur à bascule à l'arrière pour le **0** (off), puis débranchez l'imageur.*
- *D'endommager le cordon d'alimentation peut provoquer un incendie ou d'électrocution. Lorsque vous débranchez le cordon d'alimentation, tenez-le par la fiche et retirez le bouchon avec précaution.*
- *Si le cordon d'alimentation doit être remplacé, il ne remplacer que par une autre cordon d'alimentation Codonics fabriqués spécialement pour la configuration de la puissance de votre imageur.*
- *Si l'imageur est fumeur ou en faisant des sons inhabituels, éteignez et débranchez l'imageur immédiatement.*
- *Ne pas insérer d'objets étrangers dans l'imageur; cela peut constituer un danger pour la sécurité et de causer des dommages importants.*
- *Ne pas placer de récipients de liquide sur l'imageur. Si, pour quelque raison, liquide pénètre dans l'imageur, éteignez l'imageur et débranchez le cordon d'alimentation de la prise source. S'il est utilisé sans mesures correctives, l'imageur peut être endommagé.*
- *Ne pas utiliser l'imageur à proximité de gaz inflammables.*

- Avec le couvercle ouvert ou les plateaux reçoints retiré, ne touchez que les composants internes qui sont colorés en vert (montré dans la figure suivante). Enlever les bagues, cravates, bijoux et autres objets, et s'attacher les cheveux, afin qu'ils ne tombent pas dans ou à se coincer dans l'imageur.

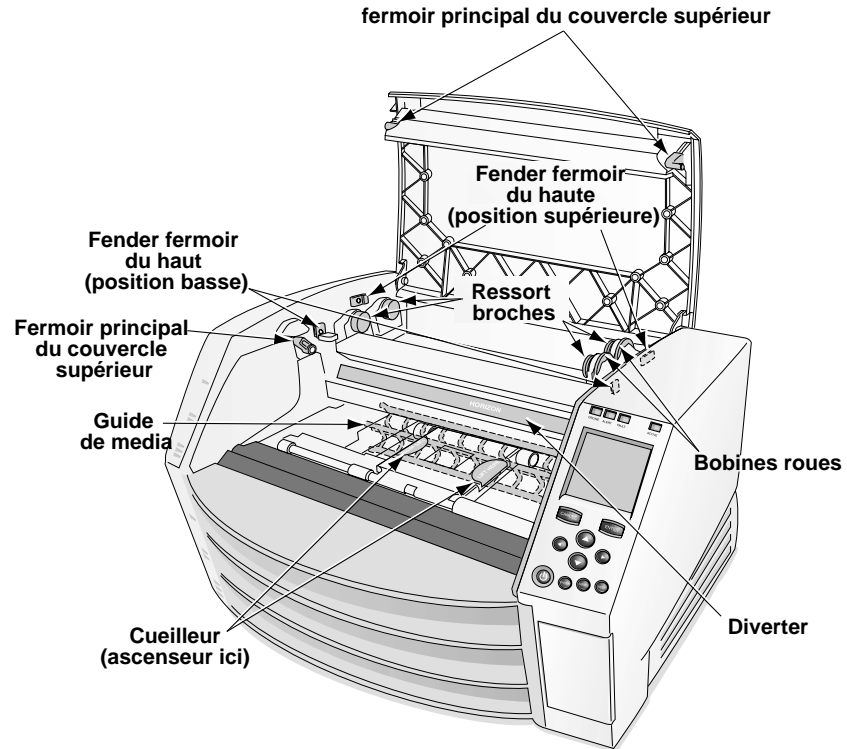

Les composants internes qui sont colorés en vert (marque dans l'illustration) sont sûre au toucher

Location Precautions

- The imager's operating ambient temperature range is 15–30°C (59–86°F), with a relative humidity of 10%–80%.
- If the imager is moved quickly from an extremely cold place to a warmer one, condensation is likely to form. Do not use the imager if condensation has formed. Wait until the condensation has evaporated. You can speed up the evaporation time by moving the imager to a dryer location.
- Ventilation slots and holes are provided on the sides and rear of the imager. Place the imager on a hard level surface and locate it at least 10 cm (4 in.) from walls to ensure proper ventilation.



CAUTION Adequate ventilation is required for proper operation of the imager.



CAUTION When positioning the Horizon Imager, ensure there is adequate space to access the rear power switch.

- Do not place imager in a high humidity or high dust area. Airborne dirt particles can cause image quality problems. Avoid placing the imager in areas where ventilation ducts, open doors, or frequent passers-by might expose the imager and media to high levels of debris.
- Do not locate the imager in hot-springs areas where hydrogen sulfide and acidic ions are likely to be generated.
- Do not locate the imager where there are oily fumes and vapors.
- Do not locate the imager in direct sunlight.
- Do not locate imager near sources of high RF energy.
- Do not locate the imager where it might be subject to jarring or vibrations, such as a table or desk in a high-traffic area. Jarring and vibrations can affect the print quality of images.

- Horizon satisfies the electrical safety limits of IEC60601-1-2 and CISPR 11 and is suitable for patient care area location. Check with local ordinances and installation guidelines to confirm approved location requirements.

Environnement de Fonctionnement

- *Les conditions normales d'utilisation de l'appareil sont : une température de 15 à 30°C et une humidité relative de 20 % à 80 %.*
- *En cas de variation rapide de la température, de la condensation peut se former. En ce cas la n'utilisez pas l'appareil, attendez que la condensation se soit évaporée. Vous pouvez accélérer cette évaporation en déplaçant l'appareil dans un endroit sec.*
- *Fentes de ventilation et les trous sont prévus sur les côtés et l'arrière de l'imageur. Placez l'imageur sur une surface plane et dure et de le localiser au moins 10 cm (4 po) du mur pour assurer une bonne ventilation.*



ATTENTION Une ventilation adéquate est nécessaire pour le bon fonctionnement de l'imageur.



ATTENTION Lors du positionnement de l'imageur Horizon, laisser un espace adéquate pour accéder à l'interrupteur d'alimentation à l'arrière.

- *Toujours placez l'appareil dans une zone propre et non-humide. Des particules de poussières peuvent causer des dysfonctionnements de la qualité d'imprimante. Évitez de placer l'appareil à proximité d'une bouche de ventilation, d'une porte, ou d'un endroit très fréquenté car cela pourrait exposer l'appareil ainsi que les étiquettes à la poussière.*
- *Ne placez pas l'appareil à proximité d'une source de chaleur ou de substances acides.*

- *Ne placez pas l'appareil dans un endroit où il y a des vapeurs huileuses et grasses.*
- *N'exposez pas l'appareil à la lumière directe du soleil.*
- *Ne placez pas l'appareil près d'une source haute fréquence.*
- *Ne placez pas l'appareil dans un lieu où il pourrait être exposé à des vibrations, car cela peut nuire l'impression des média.*
- *Horizon satisfait aux limites de sécurité électrique de la norme IEC60601-1-2 et CISPR 11 et est adapté à l'emplacement des soins du patient. Vérifiez avec les ordonnances locales et les directives d'installation pour confirmer les exigences endroit approuvé.*

Cleaning Precautions

- Many plastic components are used in the imager's construction. Coat flecking and deformation is likely to occur if the imager is wiped with chemical dusters, benzene, thinners, insecticides, or other solvents. Rubber and PVC materials left in contact with the imager for extended times will cause damage. Never use petroleum-based solutions or abrasive cleaners.
- To clean the imager cover, first power off the imager using the  (power) key at the control panel, then turn the rocker switch in the back to the **0** (off) position, then unplug the imager. Clean the cover with a soft cloth slightly moistened with a mild soap and water solution. Allow the cover to completely dry before operating the imager again.

Précautions d'Entretien

- *Il y a beaucoup des choses plastiques utilisant avec la fabrication de l'imageur. L'emploi des chiffons chimiques, de benzène, des diluants, des insecticides, ou des autres solvants peuvent causer les dommages à l'extérieur ou les déformations. Le caoutchouc ou le PVC qui ont beaucoup de contact avec l'imageur causeront les dommages. N'utilisez jamais les nettoyeuses avec pétrole ou les nettoyeuses abrasives.*
- *Pour nettoyer la couverture d'imageur, première éteignant l'imageur en utilisant la touche  (alimentation) au panneau de contrôle, puis tournez l'interrupteur à bascule à l'arrière au 0 (OFF) position, puis débranchez l'imageur. Nettoyez le couvercle avec un chiffon doux légèrement humidifié avec une solution de savon doux et d'eau. Laisser la couverture de sécher complètement avant d'utiliser l'imageur à nouveau.*

Media

- For **ChromaVista**[®] color prints, the consumed ribbon contains facsimiles of any patient images printed to **ChromaVista** color sheets. Therefore, you must properly dispose of or destroy consumed ribbon to ensure the confidentiality of patient images.
- The optical density of reflective and transmissive prints have a nominal range of: Dmin = 0.10 OD (reflective), 0.11 OD (transmissive) to Dmax = 2.10 OD (reflective), 3.0 OD (transmissive). Actual optical densities may vary based on media variations and on the instrument being used to measure density. For example, **DirectVista**[®] Clear film may have a lower Dmin and Dmax than **DirectVista** Blue film.

- Depending on the configuration, the Horizon imager includes a built-in densitometer. The built-in densitometer is designed to produce consistent prints by compensating for variation from one film cassette to another and one imager to another. For applications that require absolute control of the maximum density, the results should be checked against a bench-top commercial densitometer. The internal densitometer can be calibrated to a desktop unit. See the *Horizon Imager Technical Manual* for more information.
- **DirectVista** media is optimized for grayscale prints, while **ChromaVista** is optimized for color prints. If **ChromaVista** is not giving you satisfactory results with grayscale images, you may want to consider using **DirectVista** media for those applications.
- Media variations between different production lots may produce subtle differences in image quality and color. These variations most often occur in color ribbons and are characterized as a slight color hue in grayscale images.
- Codonics film media is designed to be viewed using a light box suitable for viewing medical diagnostic images.
- Codonics paper/white film media is designed to be viewed under cool-white, fluorescent light. Spectral differences and intensity variations in the viewing light sources can change the apparent color of images printed on paper/white film.
- Printed images that are subject to prolonged exposure to sunlight, ultraviolet light, or extreme heat may degrade in image quality. (For example, printed sheets should not be stored in an automobile on a sunny day.) Precautions should be used to avoid prolonged direct exposure.

Codonics Paper/White Film Media

The terms “white paper” and “white film” are synonymous references and used interchangeably in this manual.

File Transfer via FTP and LPR

- Different users who share a user name when transferring files to the imager may cause unpredictable and erroneous printed output. The imager associates information with the user name. Each user should have a unique user name when connecting to the imager via FTP and LPR.

Color Management

- Image settings—including gamma, contrast, Dmax, saturation, and MCM™ (Medical Color Matching™)—are intended to compensate for differences that may occur between image acquisition and image printing. These filters allow you to accurately render the final printed image. You should use care when applying these filters to avoid over compensation.
- The Default User Settings set at the control panel will potentially affect prints made by all users. Use caution when changing the default settings.

Image Scaling

- Scaling an image will filter the original image data and add or remove information, which may affect the accuracy of the final printed image. The amount of information added or removed will also vary with the magnitude of the scale factor applied. This can also affect the accuracy of the final printed image. You should be aware of the properties and limitations of each scaling algorithm and select the appropriate algorithm for the task.

Hardware Variations

- Components used in the imager may vary, causing differences in image quality. The thermal process of producing a print utilizes many components that are calibrated to provide consistency between imagers. There are subtle differences between imagers that can cause print variations. These differences usually apply to thermal print head calibration. Other factors such as age, usage, heat, mechanical wear, and shipping can affect image color and quality.
- The type of media used to install software updates and to backup imager configuration settings depends on hardware variations. If the imager has a built-in Zip drive, installations and backups are performed using 100-MB Zip disks. If the imager does not have a built-in Zip drive, USB flash drives are used with the USB ports on the rear panel. Throughout this manual, Zip disks and USB flash drives are referred to as *installation media* or *backup media*, depending on the operation being performed.



NOTE: If the imager has both a ZIP drive and a USB port, always use the ZIP disk to install software and save configuration settings.

Disposal Requirements

Disposal of this product and consumables shall be in accordance with all applicable laws and regulations in effect at the locality at the time of disposal.

Conditions et Règles d'Utilisation

L'utilisation de ce produit doit être conforme à toutes les lois et règlements applicables sur le lieu d'utilisation.

European Disposal Requirements

Codonics imagers and electronic accessory devices are not to be discarded or recycled; rather they are to be returned to the manufacturer. Contact Codonics directly or by the link provided for the latest information concerning:

- Identification of the country-specific Importer/Distributor/Producer
- Product return and treatment of our electronic products

Manufacturer: Codonics Inc.
17991 Englewood Drive
Middleburg Heights, OH 44130 USA
Phone: +1.440.243.1198
Fax: +1.440.243.1334
E-mail: WEEE@codonics.com
www.codonics.com

Codonics electronic products and accessories bearing the following symbol are subject to European Directive on Waste Electrical and Electronic Equipment (WEEE) 2002/96/EC, amended by Directive 2003/108/EC. The EN 50419 symbol indicates separate collection and return required.



EN 50419 symbol

Indications for Use



CAUTION Approved FDA Class 2 device - Federal law restricts this device to be sold for use by or on the order of a physician.

The intended use of the Horizon Series Imagers is high-resolution hardcopy imaging of digital image source material and through the conversion of electronic signals from a wide variety of direct/indirect medical imaging modality outputs. The hardcopy output includes, however is not limited to, digital radiography, nuclear medicine, ultrasound, CT, MRI, CR, and Radiation Therapy planning. Images are suitable for medical image diagnosis use and referral. The system is intended for use by medical radiologists, imaging modality specialists, and communications to referring physicians.

The Horizon Series Imagers are dry, thermal, grayscale (G, GS,GS-s,GS-Rad, G1, and G2 models) and grayscale/color (Ci, Ci-s, Ci-RAD, and SF models) direct thermal printer/imagers.

The Horizon XL is a special model adding 14 x 36-in. and 14 x 51-in. true size “long” media that permits digital direct orthopaedic application hardcopy, including diagnosis and analysis of scoliosis, weight bearing spine/hip/knee, and long bone/hip prosthetic and orthopedic appliances work-up and surgical planning. Horizon XL is applicable to true-size hardcopy of whole body CT, MRI, and Angiographic and Venous flow imaging procedures.

Horizon Imagers are 510(k) cleared to market as FDA Class 2 devices, Regulation number 892.2040, Classification Product Code LMC: Horizon Series Medical Multimedia Dry Imagers K021054 and Horizon XL Medical Long Film Imager Hardcopy Multimedia K060440.

1

Introduction

Welcome and Congratulations

Congratulations on your purchase of the Horizon Multi-media Dry Imager—the most compact, versatile imager in the world!

We are pleased you chose the Horizon imager from Codonics. We are confident that your new imager will provide fast, reliable printing for your demanding imaging applications. The Horizon imager is capable of printing images with outstanding clarity and detail.



Note that there are several models of the Horizon imager, each with different features. This manual describes all of the available features, so some may not apply to your model.

Imager Features

State-of-the-Art Printing Technology

Codonics **DirectVista** grayscale paper/white film and film, and **ChromaVista** paper/white film, are state-of-the-art imaging media that are ideally suited to CT (computed tomography), MRI (magnetic resonance imaging), digital radiography, fluoroscopy, PACS (picture archiving and communication system), ultrasound, nuclear medicine, portable X-ray, mammography, dental, and other imaging applications.

DirectVista grayscale direct thermal technology produces stunning, diagnostic-quality grayscale prints without the need for chemicals or ribbons.

The unique **ChromaVista** color dye-diffusion process transfers dyes from a multi-patch color ribbon onto specially coated paper/white film. Different levels of heat are used to regulate how much dye is transferred. The paper/white film is precisely registered in the imager so that it stays aligned during each pass, resulting in diagnostic-quality color prints. As an added benefit, you do not have to remove the color ribbon when printing to **DirectVista** grayscale media.

Small Footprint

The small footprint of the Horizon imager makes it ideal for desktop applications, allowing it to be located close to a user's workspace. Its size and weight also make the imager ideal for mobile applications.

Wide Variety of Media Types and Sizes

The Horizon imager supports output to paper/white film and film media in a wide variety of sizes. For a complete list, refer to “Ordering Media” on page 4-12.

Easy Access from a Variety of Image Sources

The Horizon imager can print extraordinary images from a variety of image sources, including:

- **DICOM Print Service Class-compliant image capture or viewing applications.** This option is explained in Chapter 5.
- **Windows and Macintosh applications via PostScript.** This option is explained in Chapter 6.
- **FTP and LPR.** Support for these sources comes standard with the imager. FTP and LPR are considered advanced printing methods, typically used by system integrators and only with UNIX applications. Basic procedures for printing via FTP and LPR are provided in Chapter 7. They are fully explained in the *Horizon Imager Technical Manual*.
- **Backup media (either a 100-MB Zip disk or a USB flash drive).** This option is explained in the *Horizon Imager Technical Manual*.
- **Codonics SA-2000 Analog Framegrabber.** Instructions for using the SA-2000 are explained in the *SA-2000 Operator Manual*.

Via its TCP/IP–Ethernet connection, the Horizon imager can support printing requests coming simultaneously from multiple devices on the network:

- DICOM (up to 12 simultaneous connections)
- DICOM Lite (1 or 2 simultaneous connections)
- PostScript (up to 11 simultaneous connections)

- FTP (up to 12 simultaneous connections)
- LPR (up to 11 simultaneous connections)



NOTE: *The number of connections may vary, depending on the imager features that you purchased.*

Support for Major Image File Formats

The Horizon imager supports printing images that are in the following image file formats:

- DICOM (including DICOM images submitted via FTP or LPR)
- PostScript
- TIFF
- BMP
- GIF
- JPEG (JFIF and Exif subtypes)
- PNM
- PNG
- DEFF (considered a variant of TIFF)
- PCX
- Sun Raster (RAS)
- SGI
- TGA
- XWD

Note that your particular configuration of the imager may not include all of the format types listed above. If your imager does not support an image file format that you need, contact your Codonics representative.

Image Formatting and Enhancement Capabilities

The Horizon imager offers powerful image processing capabilities:

- Image conversion, image scaling, and grayscale and color management are performed by a high-performance Intel processor.
- The Horizon imager eliminates the pixelation often seen when enlarging images by using sophisticated scaling algorithms such as Lanczos, Bilinear, Bicubic, and Mitchell. These scaling techniques provide flexibility for applications from medical imaging to photo reproduction.
- Image processing can be controlled through default image and sheet settings, custom settings entered from DICOM applications, in PostScript print settings, or settings associated with a selected Job Settings file. This provides maximum flexibility of output for each user accessing the imager.
- The Horizon imager will produce diagnostic-quality images with an optical density of 3.0 or greater on **DirectVista** grayscale film.

Adding Captions to Printed Sheets

Custom images can be installed in the imager for use as captions, which are added to a sheet when it is printed. This feature can be enabled and disabled for each user. For more information, refer to the *Horizon Imager Technical Manual*.

Easy Feature Upgrade

The imager can be easily upgraded to support additional features by entering feature keys. For more information about how to purchase additional features, contact your Codonics representative.

Easy Imager Personality Swap

The Horizon imager has a “personality”—its configuration and feature information—that is stored on a Smart Card. This allows you to instantly transfer the imager’s personality to another imager—say, one being swapped with an existing imager that requires service—minimizing imager downtime. For more information about the Smart Card, refer to the *Horizon Imager Technical Manual*.

Easy Software Updates and Configuration Backups

The Horizon imager includes a Zip drive or ports for a USB flash drive to support software updates and backing up imager configuration information. This provides the following benefits:

- Software and firmware releases and updates can be loaded from installation media, making system upgrades easy.
- Imager configuration information can be restored to the imager from backup media, saving you from having to reenter configuration information manually.
- Imager configuration information can be copied to another Horizon imager, saving you from having to configure other imagers manually from scratch.

2

Setting Up the Imager

Preparing for Installation

To prepare for the Horizon imager installation, review the following guidelines and requirements:

- If this is a new installation, you will need to identify a table, stand, or countertop on which to place the imager.



CAUTION Make sure that the table can support the weight of the imager [approximately 66.7 kg (147 lbs) with receive trays and three full supply cassettes installed].

- If you are replacing an existing imager, make sure that the current location satisfies the Horizon imager installation requirements.
- Select a location for the imager that meets the requirements described in “Location Precautions” on page xxxv in the Preface.
- Select a location that allows users easy access to the imager’s control panel, supply cassettes, and receive trays.
- Make sure an electrical outlet is nearby. It is recommended that you use a UPS (uninterruptible power supply) to protect the imager from voltage spikes and power outages.

- Contact field service representatives of any imaging devices or image viewing workstations that will be used with the imager, to ensure that they are available during the imager's installation to assist with setup and help troubleshoot potential problems.

Installing the Imager

The device is shipped in two cartons. The larger Horizon imager shipping carton contains:

- Horizon
- SmartCard
- Reference Guide and other printed documentation

The smaller accessory shipping carton contains:

- Receive trays
- Power cord(s)
- Ethernet cable
- Ethernet filter cable (depends on hardware configuration)
- Media ID Reader with USB Cable (optional)
- Alcohol cleaning wipes
- Operating Software installation drive
- User's and Technical Manuals disc and other printed documentation



WARNING The imager is heavy. To avoid injury, use two people to unpack and position the imager.



To install the imager

1. Move the imager box close to the desired location.
2. Open the imager box and follow the instructions printed on the box flap.
3. Carefully lift the imager from the box.
4. Position the imager at the desired location.
5. Open the Smart Card access door at the lower right front of the imager and make sure that the Smart Card is fully seated in its slot.

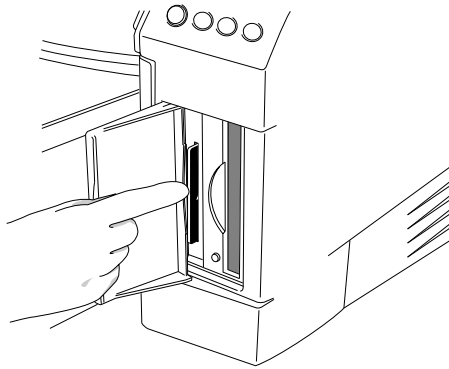

**Smart Card in slot—Horizon
with Zip drive**

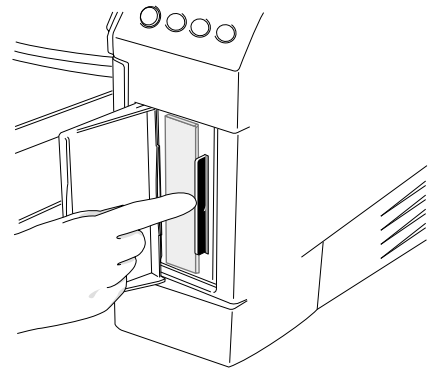

**Smart Card in slot—Horizon
with no Zip drive**

7. Plug the other end of the power cord into a suitable receptacle or into a UPS.
8. Open the top cover by pressing any of the green releases shown in the following figure.

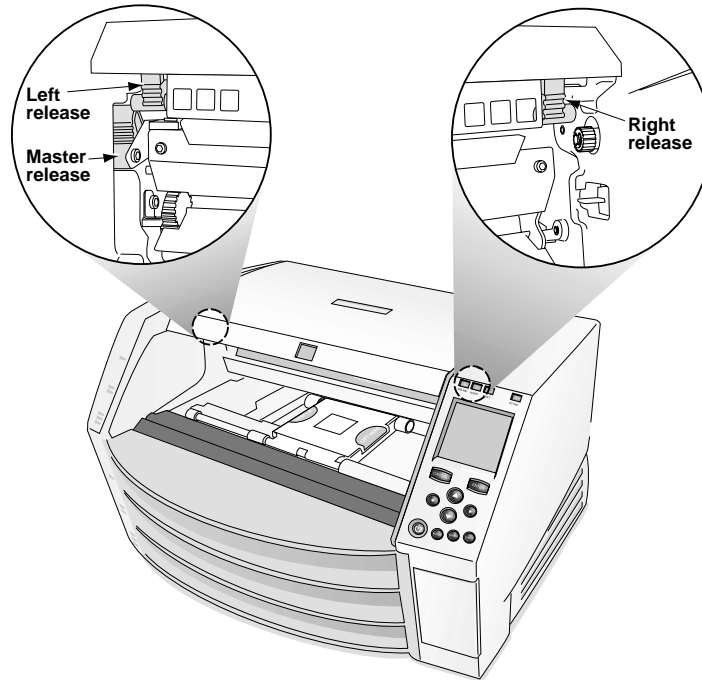

9. Remove any packing material that is inside the imager.



NOTE: If using a UPS, make sure that it is plugged into a suitable receptacle and powered on. If necessary, refer to its accompanying documentation.

- Using a platen roller wipe (refer to “Horizon Cleaning Kits” on page 10-2), gently clean the imager basement of any dust or debris.



CAUTION Do not scratch or nick the sheet metal. Scratches and nicks in the basement will damage the printed side of **ChromaVista** sheets.

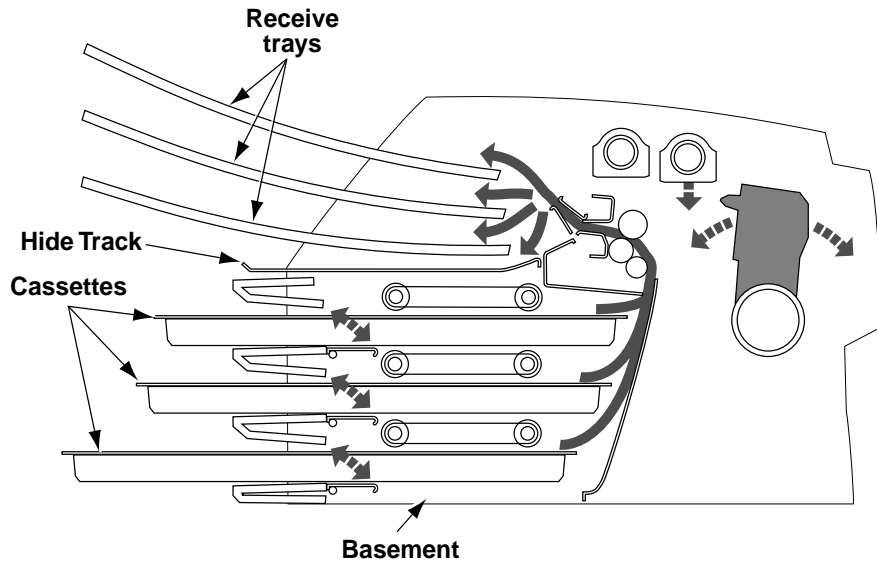

Cross-Section of Imager, Showing Location of Hide Track and Basement (with receive trays and cassettes installed)

- Remove the receive trays from their box.
- Using a platen roller wipe, clean the receive trays of any dust or debris. (For information about platen roller wipes, refer to “Horizon Cleaning Kits” on page 10-2.)



NOTE: Save the imager box and all packing material. You must reinsert any packing material and use the original box to ship the imager for any reason. Refer to “Preparing the Imager for Shipment” on page 2-26 for more information.

13. Place the receive trays into the imager, as shown in the following figure.

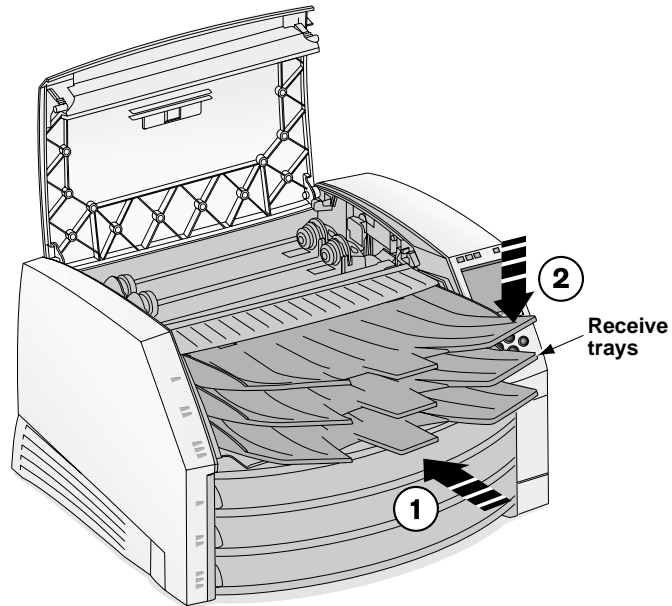

14. Close the top cover.

You are now ready to connect the Ethernet cable to the imager. Refer to the next topic.

Connecting the Ethernet Cable

The Horizon imager supports the following network cables and hubs:

- Category 5, RJ-45 [also referred to as unshielded twisted pair (UTP)] network patch cables and crossover cables
- 10/100/1000 Base-T Ethernet hubs



CAUTION Make sure that the imager is powered off before connecting the Ethernet cable. For information about powering the imager on and off, refer to “Powering the Imager On and Off” on page 3-3.



To connect the Ethernet cable to the imager

1. Locate the Ethernet cable jack at the back of the imager and insert the Ethernet cable, as shown in the following illustrations.



CAUTION Do not touch any of the connector pins.

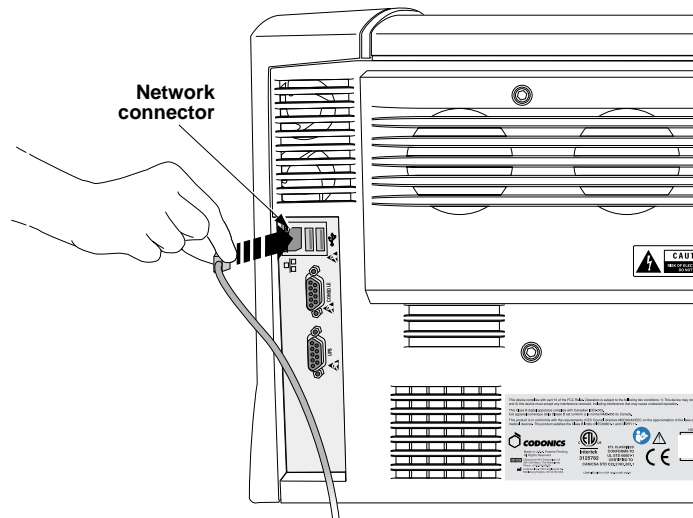

Network connector



NOTE: Depending on the specific configuration, your imager may include an optional Ethernet filter cable. If provided, make sure to insert the Ethernet filter cable into the imager network connector. Then insert the Ethernet cable into the Ethernet filter cable.



NOTE: Your imager may include an optional modem. The modem connectors look similar to the network connector (but are slightly smaller). Make sure you insert the Ethernet cable jack into the network connector. For more information about the modem (if there is one), refer to the additional modem documentation that came with the imager.

2. Connect the other end of the Ethernet cable to the Ethernet hub or, if your configuration includes only a workstation and the imager, to the workstation's Ethernet jack.



NOTE: When connecting the imager to only one workstation, you must use a special Ethernet cable, called a crossover cable. This cable eliminates the need for a hub. Optionally, you could still connect the imager and the single workstation using two standard Ethernet patch cables and a hub. This would allow for future expansion of the network.

You are now ready to power on the imager. Refer to the next topic.

Powering On the Imager—First Time



To power on
the imager

1. Press the power rocker switch located at the back of the imager to the **1** (on) position.

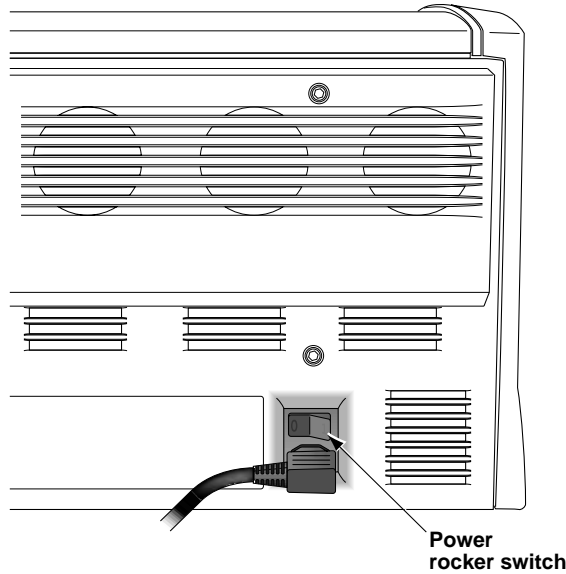

2. Press the  (power) key at the control panel.



NOTE: Always use the  key at the control panel to power on/off the imager. The power rocker switch at the back of the imager should always be in the **1** (on) position, unless the imager is being serviced or moved.

The control panel display shows startup messages as the imager initializes and warms up. When the Status screen displays (shown below), the imager is ready to receive images.

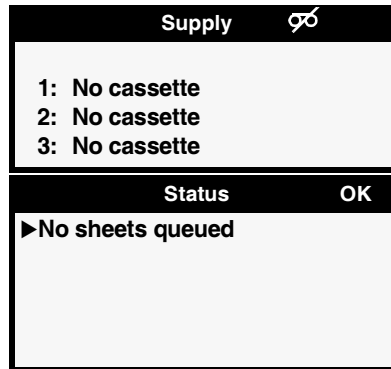

Cleaning the Platen

After powering on the imager for the first time, you should clean the platen. For instructions on how to clean the platen, refer to “Cleaning the Platen and Donor Guide Bar” on page 10-8.

Network Settings—Simple Network

This topic explains how to add the imager to a simple network. For adding the imager to a complex network, refer to the *Horizon Imager Technical Manual*.



NOTE: If your network is managed by a network administrator or an information technology (IT) department, it would be considered a complex network. You should have the responsible person perform any network-related administrative tasks.

By *simple network*, we mean a local-area network (LAN) that is *not* connected to another LAN or wide-area network (WAN). A WAN would include a connection to the Internet. (Connections to another LAN or a WAN are typically done through a device called a *gateway*.)

A simple network typically comprises several devices connected by Ethernet UTP cable through an Ethernet hub. It could also be simpler yet—a workstation or imaging device connected directly to the Horizon imager using an Ethernet crossover cable.

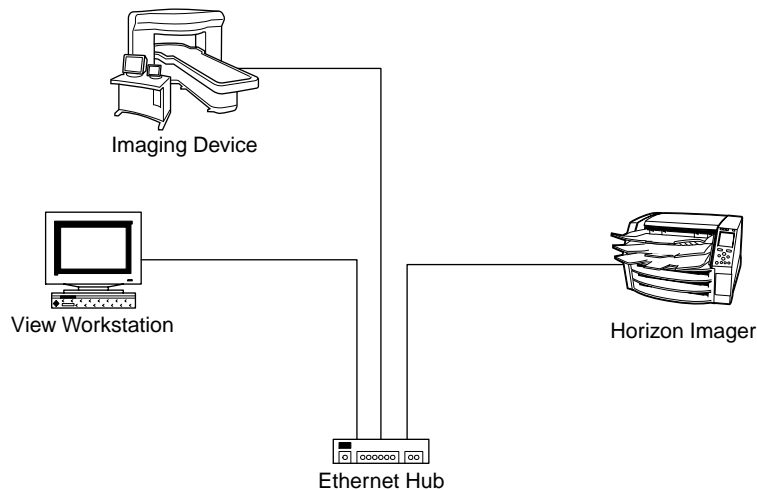

Simple Network with Ethernet Hub

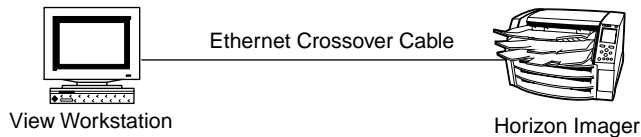

Simple Network with Ethernet Crossover Cable

In addition to physically connecting an Ethernet cable to the imager, you have to define an IP (Internet Protocol) address for the imager. This address uniquely identifies the imager on the network.

Specifying the Imager's IP Address

You must specify an IP address for the imager. This address uniquely identifies the imager on the network.

Determining an IP Address

Remember that the network connection discussion in this manual covers only simple networks—we are assuming that the imager and other devices on this simple network do not have to communicate with devices on other networks. If this is true of your network, then you only have to make sure that device IP addresses within this network are unique.



NOTE: If devices on this network **do** have to communicate with devices on other networks, it is part of a complex network. In addition to specifying the imager's IP address, the imager's subnet mask and gateway IP address may have to be specified. For more information about configuring the Horizon imager in a complex network, refer to the Horizon Imager Technical Manual.

IP addresses have the format $x.x.x.x$, where x is a value from 0 to 255. Certain IP address series have been reserved for special use by the Internet community. One series has been reserved for independent networks, like the simple network described previously in this chapter, that are self-contained and not connected to other networks. In this series, IP addresses have the format $192.168.x.x$, for which you get to define the last two parts in the address.

While you can certainly use your own IP address numbering scheme in your simple network, you might want to adopt this Internet convention. So, you might assign the IP addresses as follows:

- **192.168.1.200** to the Horizon imager
- **192.168.1.201** to an image viewing workstation on the network
- **192.168.1.202** to a second workstation
- **192.168.1.203** to an imaging device

And so on.



TIP: Labeling each device with its IP address

For convenience, you may want to affix a label to each device in the network that shows the device's IP address.

Specifying the Imager's IP Address at the Control Panel



NOTE: For a simple network, you will only need to define the imager's base IP address. You can leave all other network settings for the imager at their default values.



NOTE: For instructions on how to use the imager's control panel and menus, refer to Chapter 3.



NOTE: After entering the base IP address, note that the imager will reboot once you exit the menus so that the software can be properly updated with the new value.



To specify the imager's IP address

1. At the imager's control panel, press and hold the  key, and while holding it press the  key.

The Main Menu with administrative options displays.

2. Use the  and  keys to move the selector arrow through the option list until it points to **Network Settings**, as shown below.

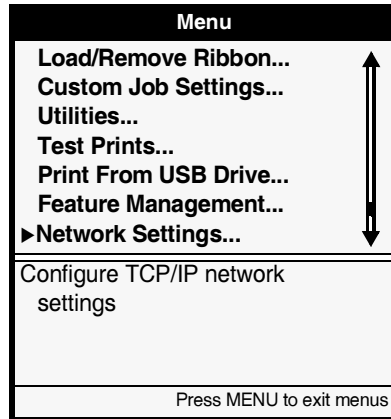

3. With the **Network Settings** option selected, press the  key.

The Network Settings menu displays. Note that the current settings are displayed in square brackets.

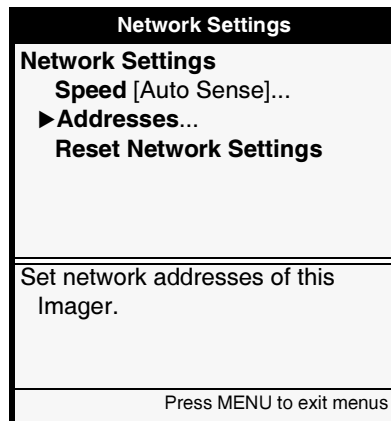

4. Select the **Addresses** option, then press the **ENTER** key.

The Network Addresses menu displays. Note that bold square *change* brackets are displayed around the first IP address octet value of the Base IP Address. The bracketed portion of the address is the portion that can currently be changed.

Network Addresses	
Base IP Address:	[0].0.0.0
Gateway:	0.0.0.0
Subnet Mask:	255.255.255.0
Number of IP Addresses:	1
Set base IP address	
Old value:	0.0.0.0
UP/DOWN to alter octet, LEFT/RIGHT to change octets	
Press MENU to exit menus	



NOTE: The Horizon imager can have more than one IP address assigned to it. For a simple network, it is assumed that you are assigning only one IP address. If so, you enter it as the Base IP Address value. For more information about complex networks and assigning multiple IP addresses to the imager, refer to the Horizon Imager Technical Manual.



5. To change the values in the Base IP Address, press the ▲ (increment) or ▼ (decrement) key until the address value you want is displayed.

Note that you can hold these keys to rapidly cycle through values.

6. To select the next value field, press the ► key. (Pressing the ◀ key moves the change brackets to the left.)
7. Repeat steps 5 and 6 until all four positions in the Base IP Address have been defined. To save what you have entered, press the **ENTER** key.



NOTE: To exit the Network Addresses menu without saving your changes, press the **CANCEL** key. The previous menu up in the hierarchy displays.

8. Press the **CANCEL** or  key to leave the Network Settings menu. A message states that the imager will automatically reboot when you press the  key to exit the Main Menu.
9. Press the **ENTER** key to acknowledge the message.
10. When you are finished specifying the IP address and want to exit the Main Menu, press the  key.

Because the base IP address was defined, the imager reboots so that it can be identified properly on the network.



NOTE: You can reset the network settings to their default values at any time by selecting the **Reset Network Settings** option in the Network Settings menu.

Specifying IP Addresses for Other Devices on the Network

Just as you did for the Horizon imager, you must specify the IP addresses for each of the other devices on the network. How you do this varies, depending on the device and its operating system. For this reason, you will have to refer to the documentation or online help that comes with the device for specific instructions.

For more information about IP addressing conventions, refer to the *Horizon Imager Technical Manual*.

Loading Media

After setting the imager's IP address, you can load media cassettes and, optionally, load a ribbon to support color prints. For more information about how to load media, refer to "Inserting or Changing Cassettes" on page 4-4 and "Changing the Ribbon (ChromaVista)" on page 4-8.

Printing the Imager Status Test Print

After the Horizon imager is set up and powered on, you should print the Imager Status test print to verify imager operation and save a record of the imager's information. There are several other test patterns to choose from to allow you to check the quality of printed images.



NOTE: For instructions on how to use the imager's control panel and menus, refer to Chapter 3.



To print the
Imager Status
test print

1. At the control panel, press the  key.

The Main Menu displays.

2. Insert a supply cassette for the media type on which you want to print the Imager Status test print into one of the supply slots.



NOTE: For detailed procedures on how to load media, refer to "Inserting or Changing Cassettes" on page 4-4.

3. From the Main Menu, select the following options.

Test Prints

media type (that is, the type inserted in step 2)

media size (that is, the media size inserted in step 2)

Imager Status

Copies

The number of copies to print displays.

4. Change the number of copies or leave as is, then press the  key.

The imager prints the Imager Status sheet.



NOTE: If a cassette with the selected media size and type is not currently loaded in the imager, or you are printing to **ChromaVista** color media and a ribbon is not loaded, the test print will not print. The imager will prompt you to insert the proper supply cassette and/or color ribbon.

Testing Network Printing

After generating a test print, try printing a sample image from each imaging device and/or image viewing workstation on the network to verify whether the network settings and cable connections are properly configured.

- If printing from one of the devices does not work, check that the device is properly connected to the network and that its IP address information is properly configured.
- If you cannot print to the Horizon imager from any device, check that the imager is properly connected to the network and that its IP address information is properly configured.

For procedures on how to print to the Horizon imager:

- To print from a DICOM application, refer to Chapter 5.
- To print from an application via PostScript, refer to Chapter 6.
- To print images from backup media, refer to the *Horizon Imager Technical Manual*.
- To send print jobs using FTP or LPR, refer to Chapter 7.
- To send print jobs using an SA-2000 analog framegrabber, refer to the *SA-2000 Operator Manual*.

Changing the Service Password

The Horizon imager is shipped with a **service** login account that provides web browser and either Telnet or SSH access to service utilities on the imager. SSH is used instead of Telnet in some newer software versions. The **service** default password should be changed as soon as possible to prevent compromising security access to the imager. For information about the **service** login, refer to the *Horizon Imager Technical Manual*.

Adjusting Image Appearance

Before starting normal operation of the imager, you may want to adjust the appearance of printed images to suit the preferences of your site. For information about how to make these adjustments, refer to Chapter 9.

Saving the Configuration Settings

Once you have the imager initially configured as you want it using the procedures in this chapter and Chapter 8, you should save those configuration settings to the appropriate backup media for your imager hardware. (Refer to “Hardware Variations” on page xli.)

If the imager settings ever become modified to an unsatisfactory state, you can always restore the imager to these initial settings from the backup media. Also, if the Smart Card ever fails, you can use the backup media to restore the imager’s configuration settings.

Saving the Configuration Settings to Backup Media



To save configuration settings

1. *If your Horizon has a Zip drive:*

- Open the Smart Card panel door at the lower right front of the imager.
- Insert a 100-MB Zip disk into the Zip drive, with the label side to the right, until it “clicks” into place.

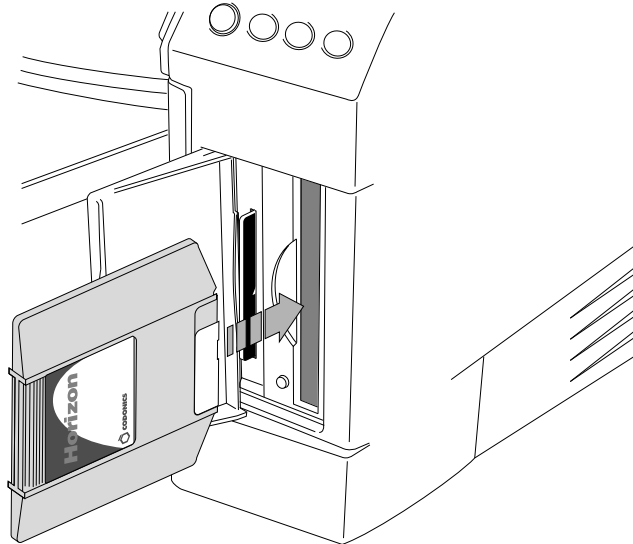

If your Horizon does not have a Zip drive, insert a USB flash drive into one of the USB ports on the rear panel of the imager.

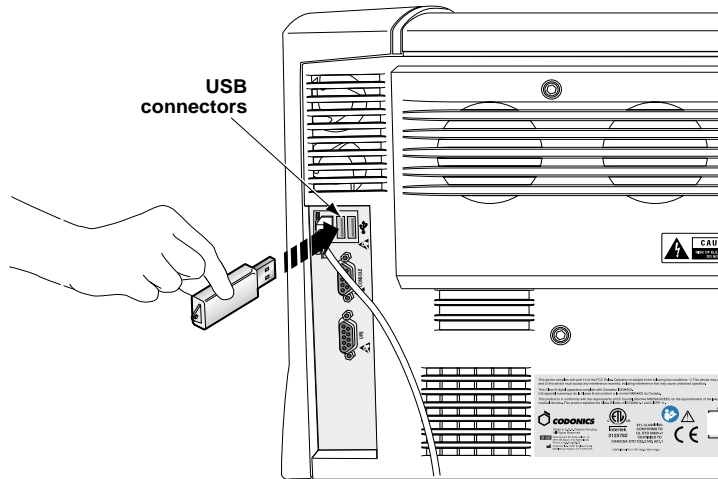

2. At the imager's control panel, press and hold the **◀** key, and while holding it press the **MENU** key.

The Main Menu with administrative options displays.

3. Select the following menu options:

Utilities
Save/Load Config
Save Config

A message prompts you to confirm that you want to save the imager configuration to backup media.

4. Press the **ENTER** key to confirm the backup operation.

The configuration information is copied from the imager to the backup media.

5. Label the fbackup media to indicate that the imager's initial configuration has been stored on it, and store the backup media in a safe place.

Managing Your Backup Media

Once you create a backup Zip disk or USB flash drive with the initial imager settings, you may not want to reuse that backup media. If you run another Save Config function with this backup media inserted, the old configuration settings will be overwritten.

It is recommended that each time you make significant changes to the imager's settings, you save them to a separate backup media. Only reuse a backup media if you are certain that you would not want to restore the configuration settings already stored on it.

Keep all backup media in a safe place.

Restoring the Configuration Settings from Backup Media



To restore
configuration
settings

1. *If your Horizon has a Zip drive*, open the SmartCard access door at the lower right front of the imager and insert the 100-MB backup Zip disk into the imager Zip drive.

If your Horizon does not have a Zip drive, insert the backup USB flash drive into one of the USB ports on the rear panel.

2. At the imager's control panel, press and hold the  key, and while holding it press the  key.

The Main Menu with administrative options displays.

3. Select the following menu options:

Utilities
Save/Load Config
Load Config

A message prompts you to confirm that you want to load the imager configuration from the backup media.

4. Press the  key to confirm the restore operation.

The configuration is copied onto the imager from the backup media. Then the imager reboots so that the restored settings can take effect.

Moving Smart Card to a Swap Imager

When swapping imagers for service reasons, the swap imager does not come with a Smart Card, You have to move the imager's Smart Card, with all its unique information—that is, its license code, configuration data, and so on—to the swap imager.



To move the Smart Card to a swap imager

1. Power off both imagers.
2. Remove the Smart Card from the imager requiring service, then insert it into the swap imager.

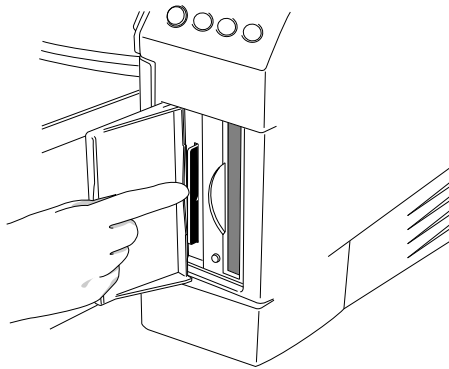

Smart Card in slot — Horizon with Zip drive

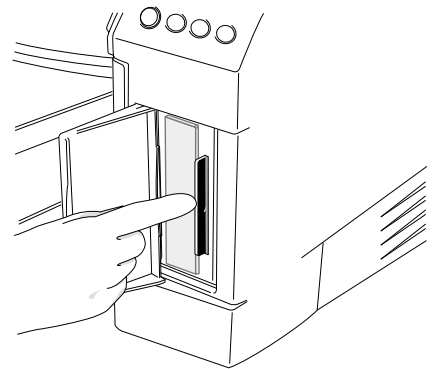

Smart Card in slot — Horizon with no Zip drive

3. Power on the swap imager.

When reinserted back into the original imager that required service, the Smart Card—and, thus, the original imager—will have any changes made on the Smart Card while in the swap imager.

Preparing the Imager for Shipment

If you have to ship the imager for any reason (for example, to return the imager to Codonics for service), you must use the original imager box and packing materials. If you do not have the original box and packing materials, contact your Codonics representative for instructions on how to return the imager.



To prepare the imager for shipment

1. If a ribbon is in the imager, remove it. For more information, refer to “Changing the Ribbon (ChromaVista)” on page 4-8.
2. Make sure the top cover is closed and the receive trays are inserted.



NOTE: *The top cover must be closed **and** the receive trays must be inserted for the thermal print head to park. If either the top cover is open or the receive trays are not inserted, the imager will display a message indicating that it cannot be shut down until the condition is corrected.*

3. Power off the imager. For more information, refer to “Powering Off the Imager” on page 3-7.
4. Remove the receive trays.

5. Open the top cover by pressing any of the green releases shown in the following figure.

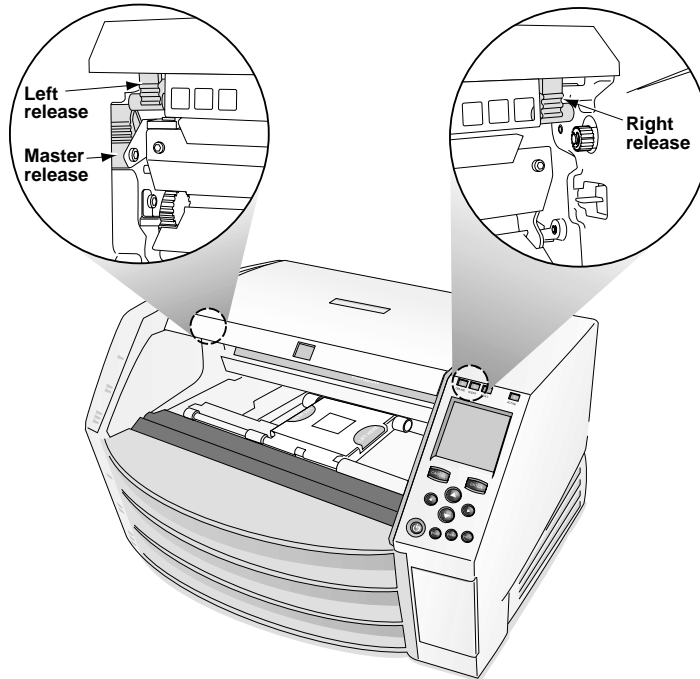

6. Make sure that the thermal print head has parked. The thermal print head should be secure with no wobble.

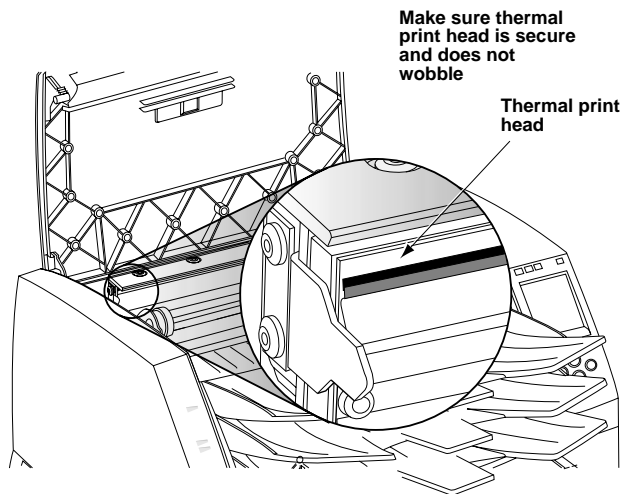



CAUTION If the thermal print head is not parked, power on the imager, then repeat steps 2 and 3 to properly power off the imager so that it does park.

7. Look down into the imager just in front of the thermal print head and make sure that the ribbon carriage is fully down to the bottom of the imager. (The ribbon carriage should have lowered during power off.)

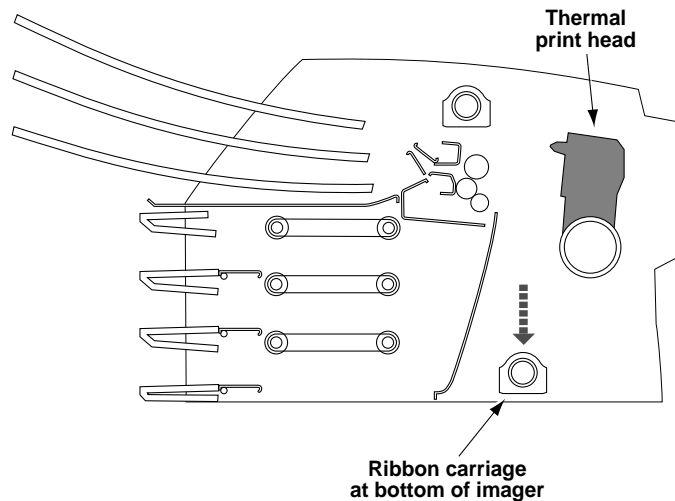

Cross-Section View of Imager



NOTE: If the ribbon carriage is not fully down, you can use the foam stabilizer to push it down. The stabilizer is shown in the first panel of the repacking illustration on the box insert. The ribbon carriage does not move easily, but it is safe to apply moderate pressure to force it all the way down.



CAUTION Push the ribbon carriage down slowly. Forcing it down too quickly may damage the carriage.

8. Replace the packing materials into the imager, close the top cover, and repack the imager into its original box. Refer to the box insert for illustrated instructions.

3

Basic Imager Operations

Horizon Imager Components

The following illustrations show the names and locations of the main imager components.

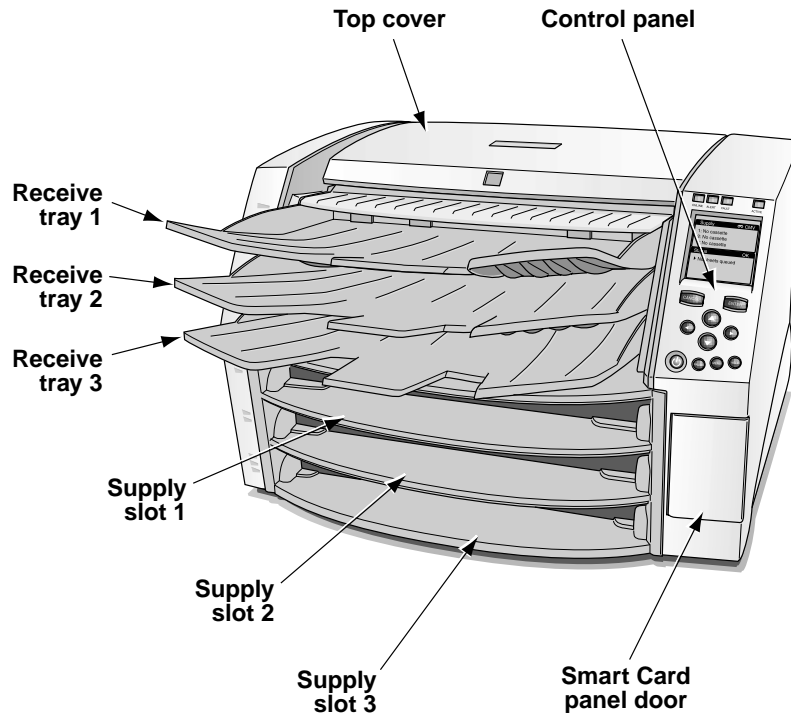

Names and Locations of the Imager's Main Components—Front

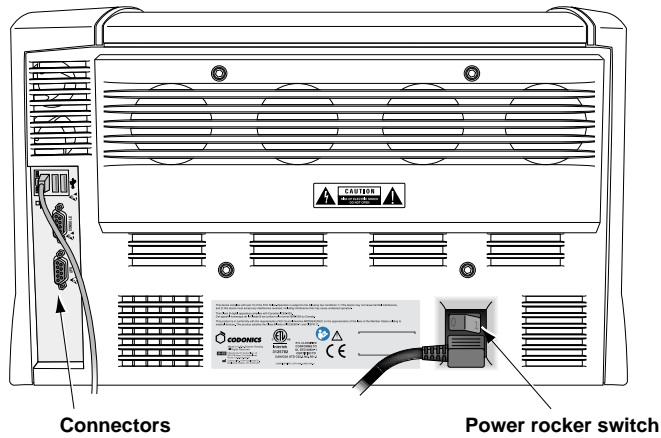

Names and Locations of the Imager's Main Components—Rear

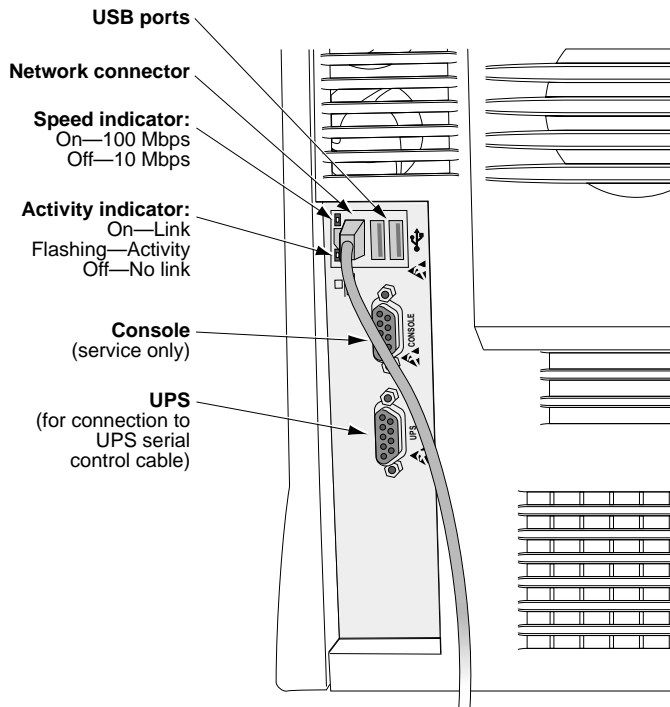

Rear Connectors

Powering the Imager On and Off

Powering On the Imager



To power on
the imager

Press the  (power) key at the control panel.

When the imager is powered on, startup status messages are displayed at the control panel display. The startup process takes 2 to 3 minutes. When the Status screen displays, the imager is ready to receive images.



NOTE: There are ways to get more detailed information about the imager's operating status. For more information, refer to the Horizon Imager Technical Manual.

Observing the Imager's Operating Status in the Status Screen

The Status screen allows you to observe the imager status. The top portion of the Status screen—the Supply window—displays the status of the three supply cassettes and whether a color ribbon is installed. The bottom portion of the screen—the Status window—displays printing status messages and the imager's operational state.

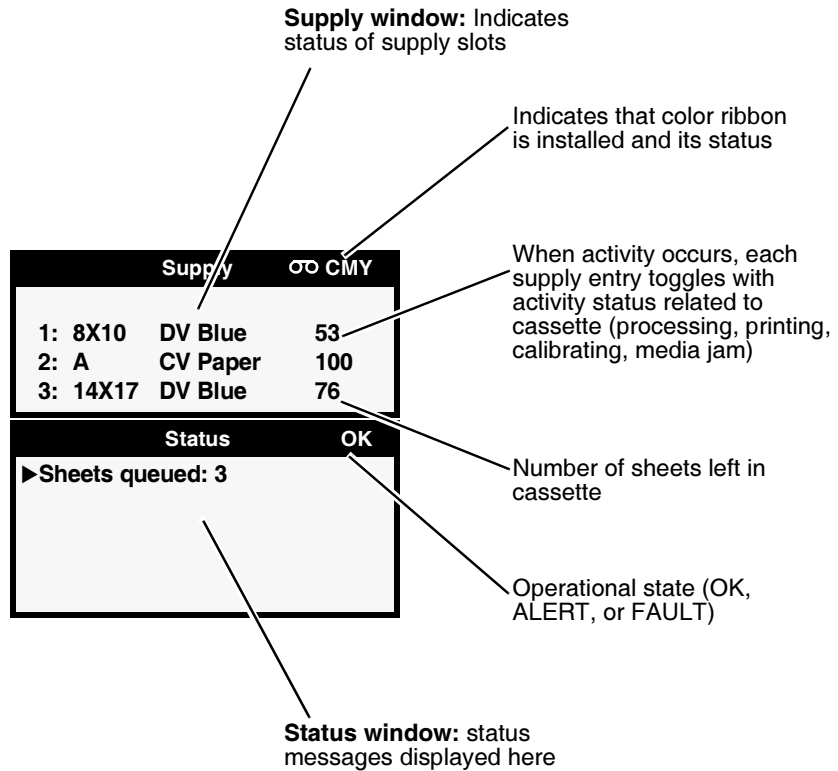

Common Cassette Status Messages

The following table lists the common cassette-related status messages.







Table 3-1. Cassette Status Messages

Message	Explanation
Barcode error	The supply cassette's barcode cannot be read.
Calibrating	The imager is performing a calibration. When performing a film calibration (when a DirectVista grayscale film cassette is first inserted, or initiated manually through the Main Menu), the "calibrating" message toggles with supply information.
Calibration failed	For a film calibration, the calibration test film is either too light or too dark, indicating that there could be a problem with the film, imager, or densitometer. Also, dust or dirt could be blocking the densitometer and affecting valid readings.
Checking cassette	The imager is reading the supply cassette's barcode, or waiting to read the barcode (for example, if the top cover is open, bar code will not be read).
Media contaminated	The media in loaded supply cassette does not match the information from the cassette's barcode. For example, cassette has been loaded with additional unknown sheets.
Media Jam	A jam as occurred with media from the indicated cassette.
<i>Media size, type, and count</i>	Indicates the type, size, and sheet count of the media cassette inserted in the corresponding supply slot. For example, 14x17 DV Blue 53 , indicating the cassette currently has 53 sheets of 14 x 17-in. DirectVista blue film.
No cassette	No cassette is loaded in the supply slot.
Printing	The imager is printing from the indicated cassette.
Unsupported media	The media in a loaded supply cassette is not supported by the imager (for example, ChromaVista color white film is loaded but that media option was not purchased with the imager). Also could mean that the imager software is out of date (out-of-date software might not support a new media type, even if the new media type's feature key is enabled).

Color Ribbon Status

The following table lists the color ribbon status indications.

Table 3-2. Color Ribbon Status Indications

Indication	Explanation
	Blank; the imager does not support ChromaVista color media.
	Ribbon loaded. Ribbon type indicated (for example, CMY for cyan/magenta/yellow).
	Ribbon loaded but the ribbon is spent.
	Ribbon not loaded (and the imager does support ChromaVista color media).
	State of ribbon being determined.
	Ribbon loaded but in an error condition.

Powering Off the Imager



To power off the imager

1. Press the  (power) key at the control panel.

The Power menu displays.

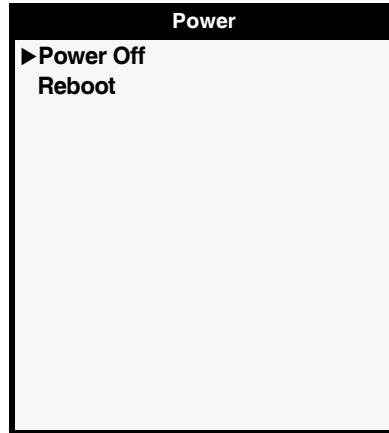

NOTE: To cancel the power off at this point, press the  key or the **CANCEL** key.

2. Select the **Power Off** option.

Shutdown messages are displayed. When the shutdown operation is complete (approximately one minute), the imager powers off.



NOTE: Always use the  key at the control panel to power on/off the imager. The power rocker switch at the back of the imager should always be in the **1** (on) position, unless the imager is being serviced or moved.



TIP: Bypassing the Power menu

To start the shutdown process without having to display the Power menu, press and hold the  key for a few seconds, until you see shutdown messages appear in the control panel display.



CAUTION If the imager is powered off using the  key, unprinted queued jobs are saved and will finish printing once the imager is powered on again (you can purge all jobs). However, if the imager is powered off using the rocker switch in the back or power is interrupted (for example, an unexpected power failure), queued jobs may be lost.



WARNING When servicing the imager, always power it off using the  key, turn the rocker switch in the back to the 0 (off) position, then unplug the imager.

Rebooting the Imager

Rather than powering the imager off, you may want to reboot the imager. For example, if you suspect that an imager problem is software-related, you could try rebooting to clear the problem.



To reboot the imager

1. Press the  (power) key at the control panel.

The Power menu displays.

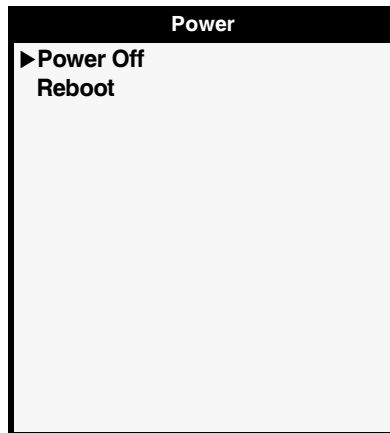

NOTE: To cancel the reboot at this point, press the  key or the **CANCEL** key.

2. Use the  key to move the selector arrow to the **Reboot** option.
3. With the **Reboot** option selected, press the **ENTER** key.

Shutdown messages are displayed. When the shutdown operation is complete, the imager reboots. The reboot process takes approximately four to five minutes.

Understanding the Control Panel

The following illustration shows the control panel display, keys, and indicators.

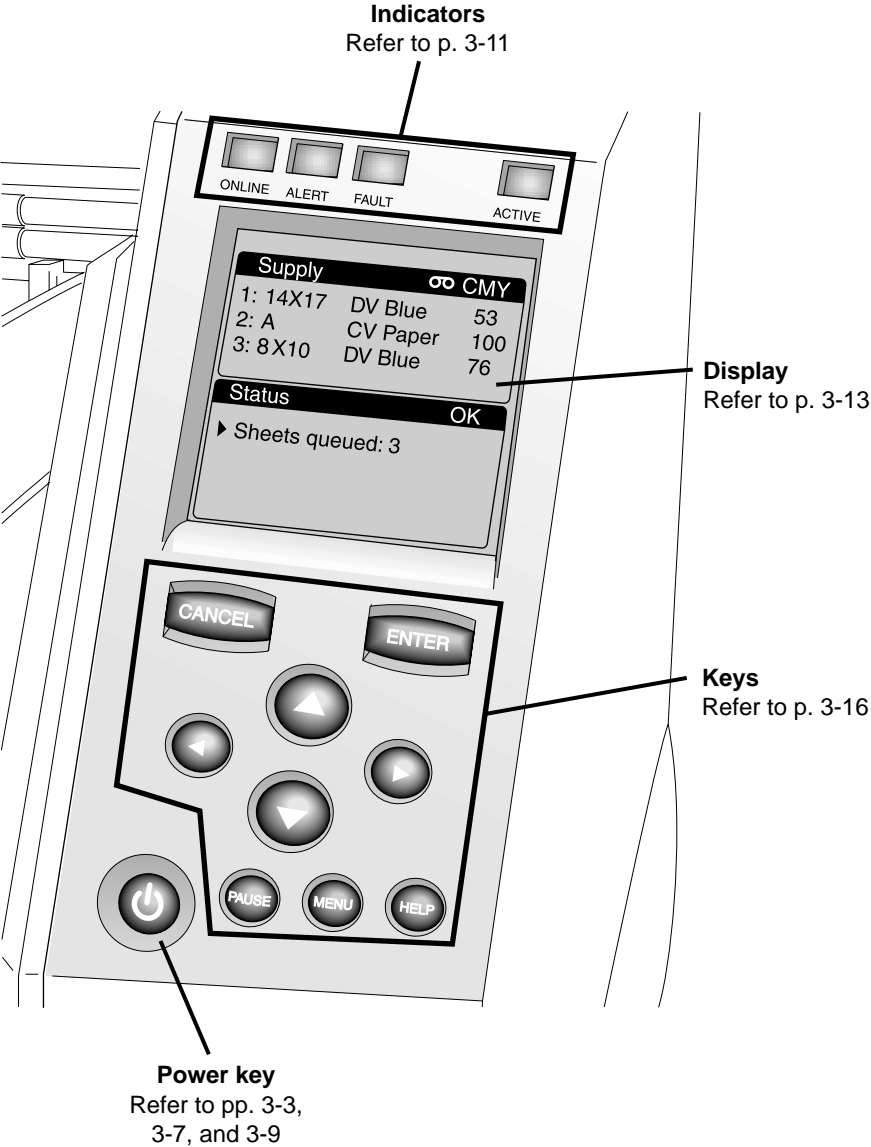

Control Panel Indicators

The following table describes the control panel indicators.

Table 3-3. Control Panel Indicators

Indicator	Description
ONLINE (green)	<p>Indicates when imager is online (lit) or offline (off):</p> <ul style="list-style-type: none"> • When online, printing is enabled. • When offline, printing is paused. <p>In both cases, the imager will continue to receive and process print jobs.</p>
ALERT (yellow)	<p>When lit, indicates a condition that requires operator attention, but printing can continue.</p> <p>An example of an alert condition is a queued job that requires a supply cassette that is currently not loaded or is empty, but other cassettes are not empty.</p>
FAULT (red)	<p>Indicates an imager fault condition that prevents the imager from printing any job and requires operator intervention. For example:</p> <ul style="list-style-type: none"> • A sheet is jammed • No supply cassettes are loaded • All supply cassettes are empty
ACTIVE (green)	<p>Has the following states:</p> <ul style="list-style-type: none"> • On: The imager is powered on but idle. • Off: The imager is powered off. • Flashing: The imager is actively receiving, processing, or printing jobs; or powering on, off, or rebooting. If jobs are stopped, the ACTIVE indicator will not flash.

Alert and Fault Messages and the Fault Tone

When the imager needs attention or an error occurs, the **ALERT** or **FAULT** indicator lights. Also, “ALERT” and “FAULT” are displayed in the Status screen’s title bar, and messages are displayed in the Status screen to help you respond properly to the condition.

If operator intervention is required (for example, there is a sheet jam), a Fault tone sounds. To stop the Fault tone, press any control panel key.



TIP: Controlling the Fault tone volume or turning it off

You can control the volume of the Fault tone, or turn it off. For more information, refer to the Horizon Imager Technical Manual.

For more information about alert and fault messages and how to respond to them, refer to Chapter 12.

Control Panel Display

Status Screen

When not displaying the Menu or Help screens, the control panel displays the Status screen. The top portion of the Status screen—the Supply window—displays the status of the three supply cassettes and whether a ribbon is installed. The bottom portion of the screen—the Status window—displays printing status messages and the imager’s operational state.

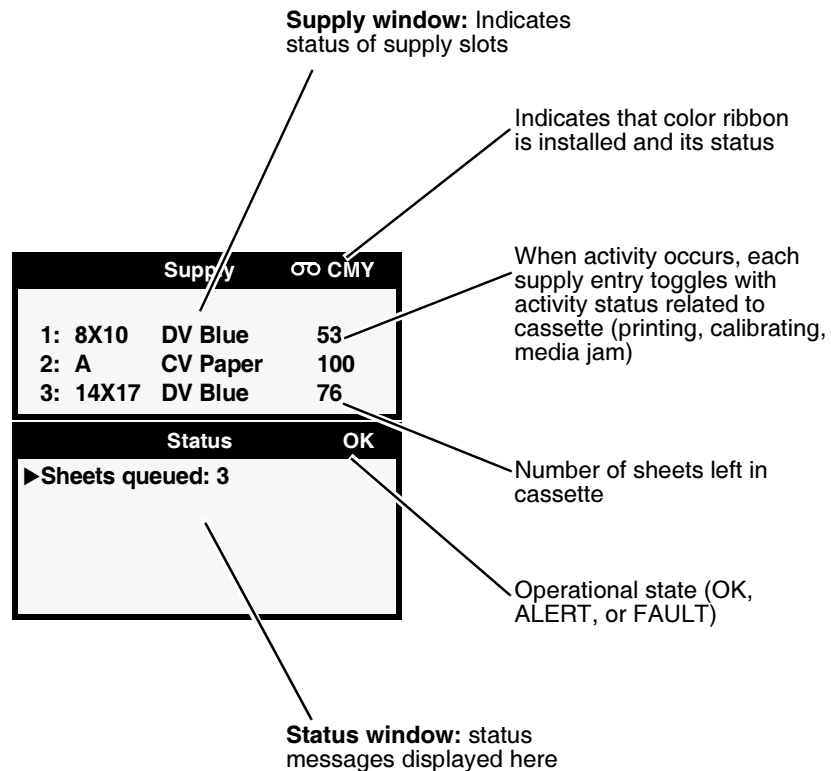

To get additional information about the currently selected status message, press the **HELP** key. For more information, refer to “Using Online Help” on page 3-23.

Main Menu

When the **MENU** key is pressed, the **Main Menu** displays. You use the Main Menu to perform the most basic and frequently used imager operations.

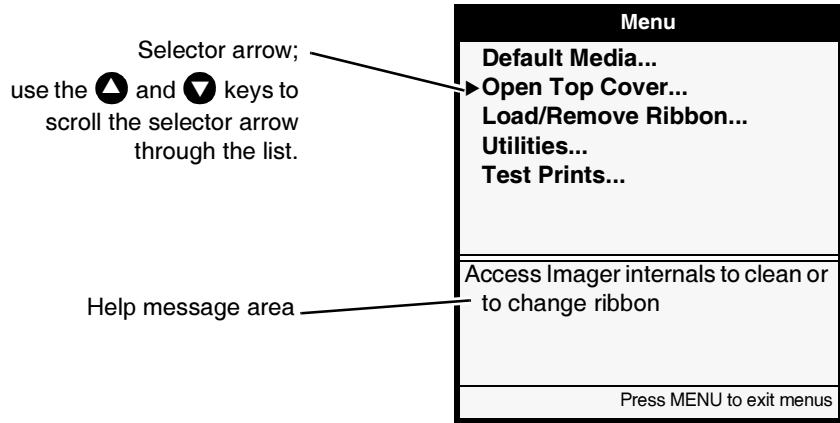

If you press the ◀ key and, while holding it, press the **MENU** key, the Status screen shows additional administrative options in the menus. You use these additional options to perform system maintenance and setup tasks.

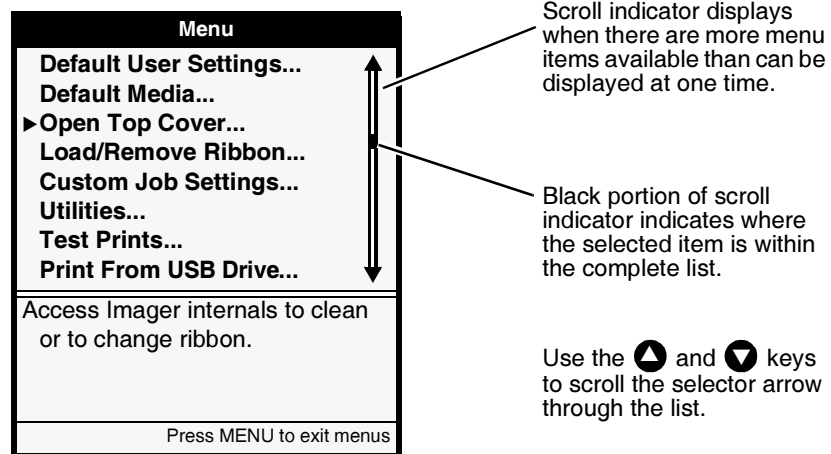

**TIP: Wrapping around a scrollable list**

Scrollable lists wrap around. That is, scrolling up past the first item displays the last items in the list. Likewise, scrolling past the last item displays the first items in the list.



**To exit the
Menu screens**

Press the  key. The Status screen is displayed.

You must always display the Status screen to see the current status of the imager. For example, if a fault occurs while you are in a Menu screen, the **FAULT** indicator will light and you will hear the Fault tone. However, to see the Fault message, you must press the  key to exit the menus and display the Status screen.

Control Panel Keys

The following table describes the control panel keys. Note that the control panel keys have backlighting:

- **A key is backlit** when it is enabled and functional within the current state of the imager.
- **A key is not backlit** when it is disabled, given the imager's current state.

Table 3-4. Control Panel Keys



















Key	Description
 key	Power key. When pressed, Power menu displays on the control panel display, allowing you to shutdown or reboot the imager.
 key	Displays the Main Menu on the control panel display, or exits the menus and redisplay the Status screen. If you made a change without first saving it, you will be prompted as to whether you want to save your changes. The Main Menu includes options that are typically performed by normal operators.
 key is pressed and held, then simultaneously the  key is pressed	Displays the additional administrative options in the menus.
 and  keys	With menu options displayed, these keys scroll the selector arrow up and down through the menu options. Scrolling down past the last option wraps around to the top of the option list. Scrolling up past the first option wraps around to the bottom of the list. To move the selector arrow rapidly through available options, press and hold either of these keys. When entering data, these keys increment or decrement the characters in the change brackets. To cycle rapidly through available values, press and hold either of these keys. If you reach the end of the value range, there is a slight pause, then the value at the other end of the range displays.

Table 3-4. Control Panel Keys

Key	Description
 and  keys	<p>With menu options displayed:</p> <ul style="list-style-type: none"> The  key chooses the currently selected menu option. The  key goes back to the previous menu. <p>When entering data, these keys move the change brackets left and right to selected character locations. When arrowing past a selection at the end of a line, the change brackets wrap to the selection at the other end of the line.</p>
 key	<ul style="list-style-type: none"> Chooses the currently selected menu option (same as pressing the  key). Saves any current changes you have made to a setting. Answers “Yes” to a message prompt.
 key	<ul style="list-style-type: none"> Redisplays previous menu (same as pressing the  key). Discards any current changes you have made to a setting, and redisplay the previous menu. Answers “No” to a message prompt.
 key	<p>Pauses or resumes printing. While paused, the imager will still receive and process jobs, but will not print them.</p> <p>After pressing the  key to pause the imager, the imager will go back online after a site-configurable time-out if there is no other user activity at the control panel and the imager is not in a Fault state.</p> <p>When the imager is paused but normal operation can be resumed, the  key flashes.</p>
 key	<p>Displays context-sensitive help, based on state of the imager and the control panel display.</p>



Navigating the Control Panel Display

From the control panel, you press the appropriate keys to access menus, make menu selections, and enter data into the imager.

To demonstrate how to navigate the control panel display, let's assume you want to change the imager's IP address. Here is what you would do.





To navigate the control panel and enter an IP address

1. At the imager's control panel, press and hold the  key, and while holding it press the  key.

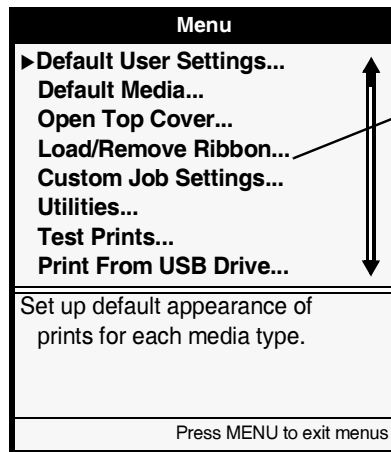
The Main Menu with administrative options displays. The selector arrow automatically points to the first menu option.



Ellipses (...) following a menu option indicate that selecting that option will display a follow-up screen for viewing and selecting additional options, entering data, or viewing information

2. To scroll through the menu options, press the  and  keys. The selector arrow (►) moves up and down through the list. The bottom portion of the control panel display shows a message associated with the currently selected menu option.



TIP: Displaying more information about a menu option

You can display more information about the currently selected menu option by pressing the

 key.

3. Point the selector arrow (▶) to the menu option you want.

In this example, you would point the selector arrow to **Network Settings**.

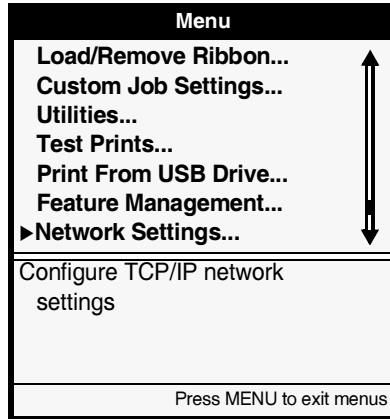

4. Press the **ENTER** key.

This selects the **Network Settings** menu option, and moves down a level to the Network Settings submenu.

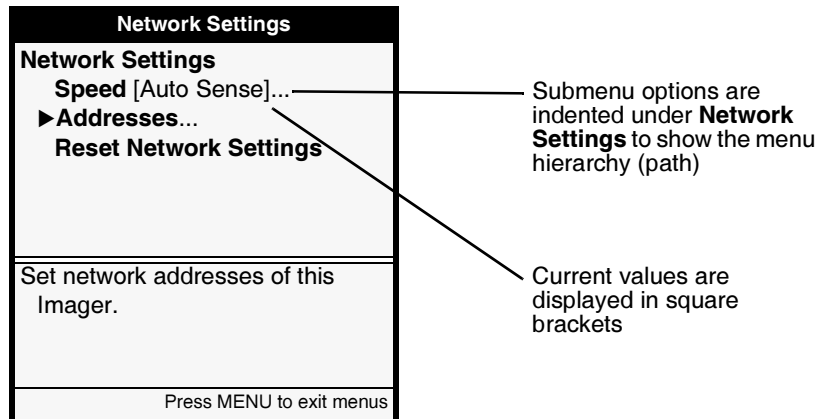

5. Press the ▲ and ▼ keys to select the menu option you want.

In this example, you would select **Addresses**.

6. Press the **ENTER** key.

The next menu allows you to enter the IP address.

Bold change brackets indicate that you can edit the bracketed value

Network Addresses	
Base IP Address:	[0].0.0.0
Gateway:	0.0.0.0
Subnet Mask:	255.255.255.0
Number of IP Addresses:	1
Set base IP address	
Old value:	0.0.0.0
UP/DOWN to alter octet, LEFT/RIGHT to change octets	
Press MENU to exit menus	

Notice that bold square *change* brackets are displayed around the first Base IP Address value position. The bracketed portion of the address is the portion that can currently be changed.

7. To change the value, press the **▲** (increment) or **▼** (decrement) key until the address value you want is displayed. Note that you can hold these keys to rapidly cycle through values.
8. To select the next value field, press the **▶** key. The change brackets move to the next portion of the address. (Pressing the **◀** key moves the change brackets to the left.)
9. Repeat steps 7 and 8 until all four positions in the Base IP Address have been defined.
10. When you are finished entering the IP address values, press the **ENTER** key to save it.



NOTE: To exit the IP Address screen without saving your changes, press the **CANCEL** key. The previous menu up in the hierarchy is displayed.

11. Press the **CANCEL** or  key to leave the Network Settings menu.

A message states that the imager will automatically reboot when you press the  key to exit the Main Menu.

12. Press the **ENTER** key to acknowledge the message.

13. When you are finished specifying the IP address and want to exit the Main Menu, press the  key.

Because the IP address was redefined, the imager reboots so that it can be identified properly on the network.

Canceling Your Changes in a Screen

To exit a screen without saving your changes, press the **CANCEL** key. Your changes are ignored and the previous menu up in the hierarchy is displayed.

Exiting the Menus

To exit the menus, press the  key. You are returned to the Status screen.

Summary of Menu Conventions

The menu displays include the following conventions:

- As you move down into the menu structure, the menu path you have taken is always shown. The hierarchy of chosen menu items is sequentially indented.
- A menu option that is followed by ellipses (...) indicates that selecting that option will display a follow-up screen for viewing additional options, entering data, or viewing information.
- Current settings are displayed in square brackets. Bold square brackets indicate that you are in edit mode and can change the setting.

The Pause State

You must pause the imager:

- If you want to replace a supply cassette. If you pull the cassette out while the imager is picking the sheet, it could cause a jam. Or, if the sheet is already printing and you pull the cassette, it could cause an artifact to be printed on the sheet.
- If you want to temporarily stop printing.

The imager automatically enters the Pause state due to certain conditions, such as if you select the Open Top Cover function from the Utilities menu to clean the thermal print head or platen, or if a sheet jam occurs.

Pausing the Imager



To pause the imager

Press the  key.

Printing pauses. If a print is in progress, the sheet completes printing before the imager pauses.

When the imager is paused, the **ONLINE** indicator is off, a message indicating that the imager is paused is displayed, and the  key flashes (if not in a Fault state) to remind you to press it to resume normal operation once you have completed the activity.

Resuming Printing



To resume printing

With the imager in the Pause state, press the **PAUSE** key again to resume normal printing operations. If the imager has paused due to a fault state, it will go back to the active state automatically several seconds after the fault condition is corrected, without you having to press the **PAUSE** key.



NOTE: If you do not press the **PAUSE** key at the completion of maintenance operations, normal printing operations will resume automatically after a predefined time-out period if the imager is not in a Fault state. For information about how to adjust the time-out period (typically, one minute), refer to the Horizon Imager Technical Manual.

Using Online Help

The Help function provides context-sensitive instructions for imager functions, parameters, and status messages. It also provides service contact information.

Help text is displayed in two ways:

- When any menu is displayed, help text relevant to the currently selected menu option is automatically displayed in the Help message area of the screen.
- By pressing the **HELP** key. Pressing the **HELP** key displays additional help text relative to the currently selected menu option, currently selected status message, or state of the imager. This additional help is displayed in its own Help window on top of the current screen. You dismiss this Help window by pressing the **HELP** or **CANCEL** key.

4

Media Handling and Storage

Overview

Supply Slots and Cassettes

Media used with the Horizon imager is prepackaged in factory-sealed, disposable cassettes.



Each cassette contains a barcode that identifies the:

- Media type and size
- Number of sheets in a new cassette
- Serial number
- Sensitometry information

The barcode also allows the imager to track how many sheets remain in the cassette (this count will be inaccurate if sheets have been manually added or removed, or the cassette has been moved to a different imager).

In addition to the barcode itself, the cassette's lot number and "Use by" date are printed on the barcode label.

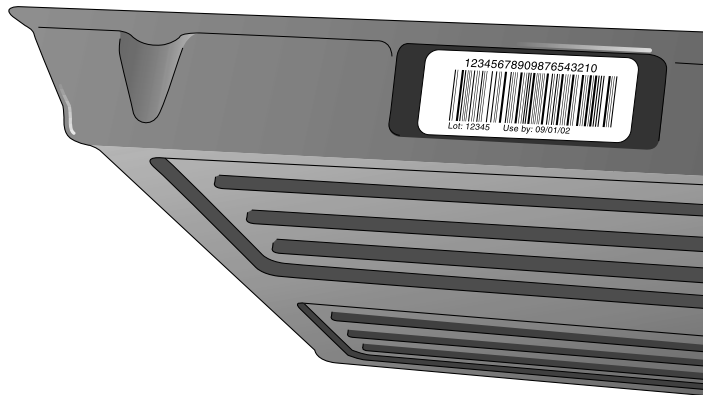

All cassettes can be loaded into any of the imager's three supply slots. However, the logical way to load cassettes would be to insert the smaller ones at the top and the larger ones at the bottom. This ensures that you can readily see each cassette's label and see whether there are sheets in any of the receive trays.



CAUTION Use only Codonics media. Do not use plain paper, office transparencies, or other unapproved media as damage, improper operation, or malfunction may result. For information about the approved Codonics media types and sizes, and how to order cassettes, refer to "Ordering Media" on page 4-12.



CAUTION Do not refill a cassette. Do not tamper with or remove the barcode label. The cassette's barcode information is essential for ensuring diagnostic image quality. Compromising the cassette in any way jeopardizes the quality and reliability of the imager.

Viewing the Status of a Supply Slot

The Status screen shows the status of each supply slot, including media type, size, and number of sheets remaining in the cassette.

Supply		CMY
1:	8X10 DV Blue	53
2:	A CV Paper	100
3:	14X17 DV Blue	76

Status	OK
▶ 3 sheets queued	

The cassette information in the Status screen does not update if:

- The top cover is open
- The receive tray is removed
- The imager is printing

Receive Trays

The Horizon imager has three receive trays. By default, sheets are printed to the receive tray that corresponds with the supply slot used. For example, if a sheet was fed from a cassette in supply slot 1, then the printed sheet is output to receive tray 1.



NOTE: To override the default receive tray, some DICOM user applications will allow you to select the desired receive tray. You can also choose a receive tray in the PostScript printer settings (refer to Chapter 6), or use a Job Settings file that specifies a specific receive tray (refer to the Horizon Imager Technical Manual).

Inserting or Changing Cassettes



To change a
supply
cassette

1. Press the **PAUSE** key, and wait until the imager enters the Paused state.

The **ONLINE** indicator turns off and the Status screen indicates that the imager is paused.

If a sheet is currently being printed, the sheet will complete printing before the imager enters the Paused state. While paused, the imager can still receive and process jobs.



CAUTION Do not remove or insert a cassette while a sheet is being printed, or you could affect the image quality of the printed sheet or cause a jam. Always pause the imager first.

2. Remove the cassette if one is currently in the supply slot you want to use—lift the cassette up slightly and slide it from the supply slot.
3. If inserting a new cassette, remove the clear wrapping from the cassette. Use the pull strip to tear the clear wrapping.

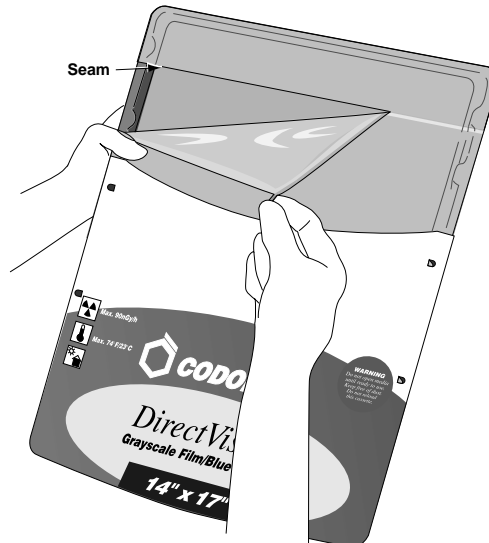



CAUTION Do not remove the printed cassette cover; it protects the media from dust and other contaminants. Always hold and store the cassette with the open side up to prevent the sheets from falling out.

4. Insert the new cassette into the supply slot, with the cassette label facing you and the barcode label to the left.



5. Slide the cassette into the supply slot until you feel the cassette settle into the retaining detent.



NOTE: Not all cassettes are the same length, so larger cassettes will extend out further than shorter ones.

6. Press the **PAUSE** key to resume printing.

Determining Which Cassette to Use

When a print job is sent, the media type and size are specified in the print job.

- If the specified media type and size are supported by the imager and the required supply cassette is not loaded, the imager will display a message on the Status screen prompting you to insert the appropriate cassette or ribbon.
- If the specified media type and size are *not* supported by the imager, the default type and size is used. Refer to “Changing the Default Media Type and Size” on page 8-3 for more information about setting the default type and size.

Handling and Storing Media

For best results when storing and handling media, refer to the storage and handling instructions that come with the media.

Break-Off Leaders (ChromaVista Only)

ChromaVista color paper/white film have break-off leaders at the top and bottom to allow edge-to-edge printing:

Bend the leader at the perforation line fully one way, then fully the other way. The leader will break away from the sheet.



To remove the
break-off
leader

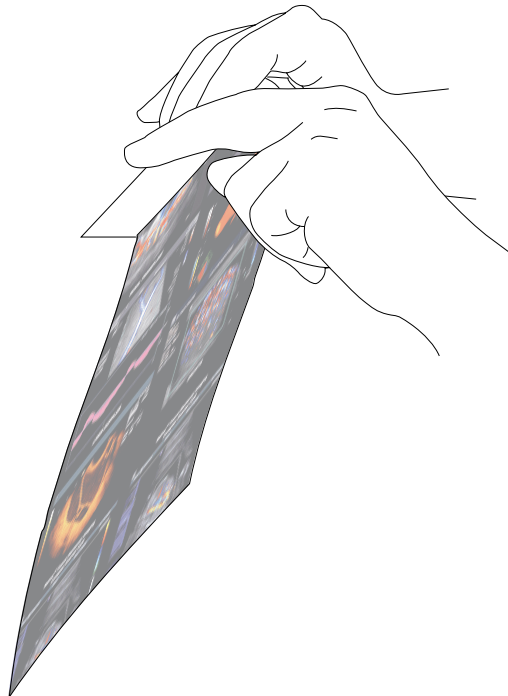

NOTE: Always bend the leader to remove it—do not tear it off—to avoid having stray pieces left on the sheet.

Changing the Ribbon (ChromaVista)

When the ribbon on the ribbon spools has been consumed and needs to be changed:

- The imager enters the Alert state.
- The word “OUT” flashes in the Status screen title bar next to the ribbon symbol (∞) instead of displaying the ribbon type.
- A message indicating that a new ribbon needs to be loaded is displayed in the Status window.



To change the color ribbon

1. Press the  key.
The Main Menu displays.
2. Select the **Load/Remove Ribbon** menu option.

After selecting this option:

- The imager pauses, first completing the sheet if one is currently printing.
 - The ribbon supply spool inside the imager rises.
 - After up to a minute to allow the thermal print head to cool, the imager cover pops partially open.
3. Lift the cover all the way open, and locate the ribbon spools.



WARNING With the imager cover open, touch only those internal components that are colored green (refer to the figure on page xxxii). Remove rings, ties, jewelry, and other items, and tie back hair, so that they do not fall into or get caught in the imager.

4. Remove the old ribbon, as shown in the following figure.

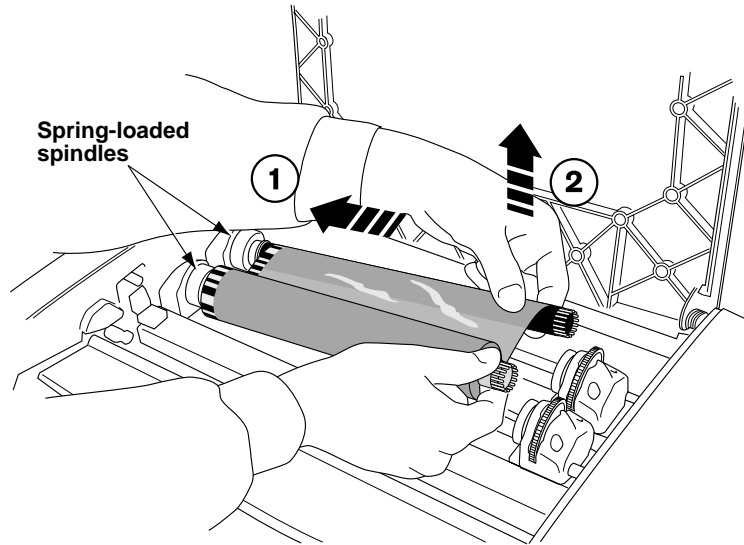

5. Load the new ribbon, as shown in the following figure.

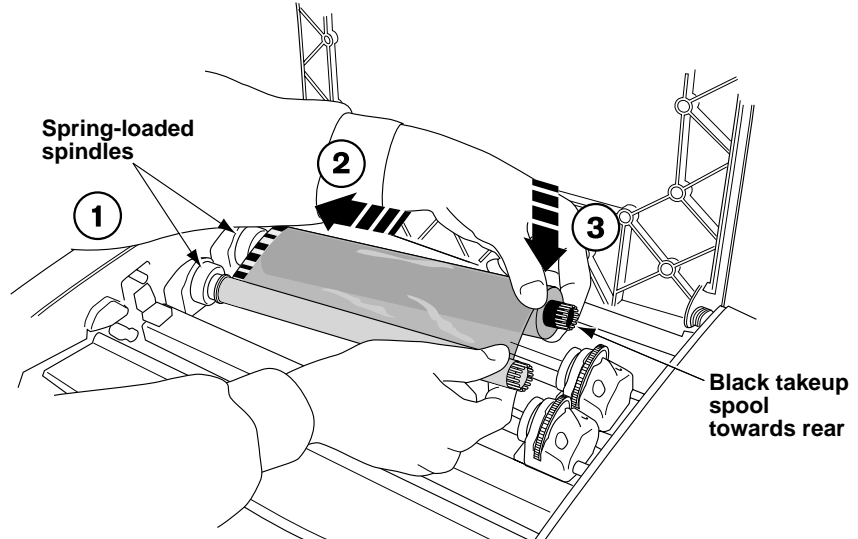

6. To take up any ribbon slack, rotate the top of the take-up spool's wheel (that is, the front wheel) towards the back of the imager, as shown in the following figure.

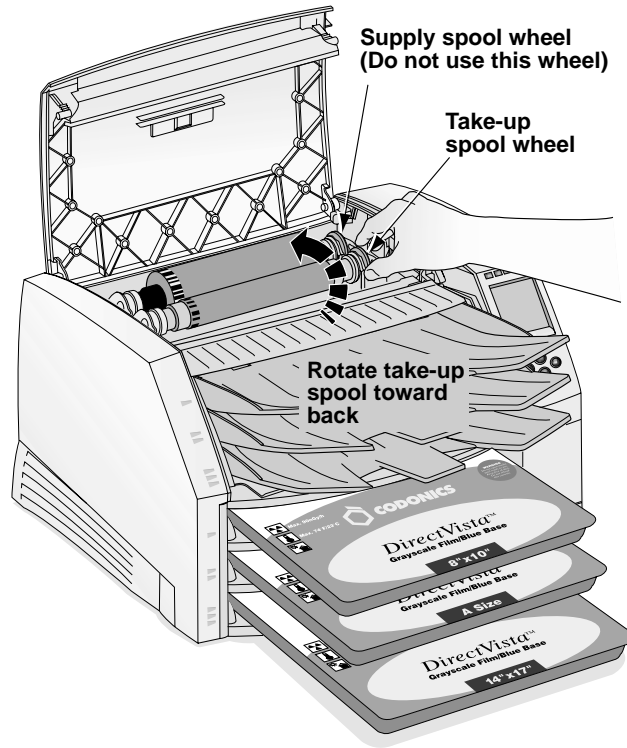

NOTE: Do not use the supply spool (rear) wheel to take up ribbon slack. This would cause spent ribbon to be reused.

7. When you are finished changing the ribbon, close the top cover.

After several seconds, the imager will leave the paused state and resume printing.



CAUTION Used ribbon retains the negative of the color images that were printed using that ribbon. If you are required to ensure patient confidentiality and privacy, the ribbon should be destroyed.



TIP: You can leave the ribbon in the imager

*The only time you need to remove the ribbon is if you are cleaning internal components or the ribbon has been consumed. Otherwise, you can leave the ribbon in the imager, even when printing to **DirectVista** grayscale media.*

Ordering Media

The Horizon imager supports a variety of paper/white film and film for both grayscale and color prints. Not all Horizon imager configurations support all media types and sizes. If your Horizon imager does not support the media type and/or size you want to use, contact your Codonics representative.

The following table shows the currently supported media size/type combinations:

Media Type	Size	Catalog Number
DirectVista Paper/White Film	A (8.5 x 11 in.)	A-DVP
	A4 (210 x 297 mm)	A4-DVP
	11 x 14 in. (28 x 35 cm)	1114-DVP
	14 x 17 in. (35 x 43 cm)	1417-DVP
DirectVista Film Blue	8 x 10 in.	810-DVB
	11 x 14 in.	1114-DVB
	14 x 17 in.	1417-DVB
DirectVista Film Clear	8 x 10 in.	810-DVC
	14 x 17 in.	1417-DVC
ChromaVista Paper/White Film	A	A-CVP
	A4	A4-CVP



NOTE: Some of the media type/size combinations listed here may not currently be available.

DirectVista grayscale media is orderable by the case, at 5 cassettes per case, with 100 sheets of film per cassette and 80 sheets of media per cassette.

ChromaVista color media is available in packages that contain 2 media cassettes and 1 color ribbon. **ChromaVista** cassettes contain 50 sheets of paper/white film.

To order media, contact Codonics at:

Phone: +1.440.243.1198
Toll Free: 800.444.1198 (USA only)
Fax: +1.440.243.1334
Web Site: www.codonics.com

5

Printing from DICOM Applications

The printing procedures covered in this chapter assume that the DICOM support option is installed in your Horizon imager and that you are sending print jobs from a DICOM application. DICOM applications typically run on an imaging device or on an image viewing workstation.



NOTE: *If you are running DICOM Lite on the imager and see connection errors at the console or workstation from which you are sending print jobs, you may require more connections than DICOM Lite provides. Contact Codonics technical support for assistance (refer to “Contacting Technical Support” on page 12-30).*

Introduction to DICOM

DICOM (Digital Imaging and COmmunications in Medicine) is the industry standard for transferring images and other medical information from radiology, cardiology, ophthalmology, endoscopy, mammography, and many other medical modalities with other devices. DICOM provides a common platform so that systems from various manufacturers can transfer images and related information.

For example, workstations, CT scanners, MR imagers, film digitizers, shared archives, film imagers, and host computers made by different vendors and located at the same or different sites can “talk to one another” by means of DICOM across an “open-system” network.

A device or application is said to be DICOM-compliant when the manufacturer declares that its device will follow the rules defined in the DICOM standard for its device type. The Horizon imager is DICOM Print Service Class-compliant. It is anticipated that most print jobs will be sent to the Horizon imager from DICOM Print Service Class-compliant imaging devices or image viewing workstations.

For more information about DICOM, visit the official web site—medical.nema.org. Additional information is available at the web site of the Radiological Society of North America, Inc. (www.rsna.org).

DICOM Conformance Statement

Vendors who claim that their device or application conforms to DICOM must publish a *conformance statement* that describes how it conforms. Most devices or applications will not support all of the features of a particular DICOM service. Whether each feature of the service is supported or not would be included in the conformance statement.

The vendor or person responsible for implementing the Horizon imager will study the conformance statements for the Horizon imager and for any other DICOM devices or applications that will be sending print jobs to it. By examining these conformance statements, the implementor will determine exactly what DICOM Print Service Class Provider options the Horizon imager supports. The implementor will also be able to tell if the other devices will be compatible with the imager.

The Horizon imager conformance statement is available on the Codonics web site (www.codonics.com). It can also be mailed or faxed to you on request.

How a DICOM Print Job Is Processed

A DICOM print job transaction consists of two participants:

- **The device making the print request.** This can be an imaging device (such as an MRI or ultrasound system) or an image viewing workstation at which an image is being displayed. In DICOM terms, this device is referred to as a *Print Service Class User*.
- **The device that will service the print request** and print the image on a sheet—for example, the Horizon imager. In DICOM terms, this device is referred to as a *Print Service Class Provider*.

To identify the DICOM Print Service Class User application, the application is assigned a unique name—the *Calling AE* (application entity) *Title*.

To identify a Print Service Class Provider application, it also is assigned a unique name—the *Called AE Title*.

Configuring the DICOM Application

Your key operator or DICOM application vendor must configure the DICOM application running on each imaging device or image viewing workstation to support printing to the Horizon imager.

To properly configure a DICOM application to support printing to the Horizon imager, you need to know the Called AE Titles that can be used to identify the imager, and its TCP port number.

The port number is **104**. The Called AE Titles are listed in the following table, which also describes how they are used.

Called AE Title That Can Be Used	Description
Print_SCP	For standard print jobs.
SpecialBracket	For printing bracketing sheets. For more information, refer to Chapter 9.
SpecialSlide	For printing 35-mm slides. For more information, refer to the <i>Horizon Imager Technical Manual</i> .
<i>The name of a Job Settings file</i>	For printing using Job Settings files to specify print job parameters.

For more information about the Horizon information needed to perform this configuration, refer to the *Horizon Imager Technical Manual*.

Sending a DICOM Print Job

How you select a Horizon imager as a destination, then send a print job to it, is unique to your specific DICOM user application. For details, refer to your key operator, DICOM user application vendor, or the accompanying DICOM application documentation.

Specifying the Media Type and Size

Typically, you will set the media type and size to use for a given print job from within the DICOM user application. However, if your DICOM user application does not support making these settings, you have two other options:

- Simply send the print job. The Horizon imager can determine whether the image is grayscale or color. The imager will then use the default media type/size defined for the image type. For more information about how to define the default media type/size to use for grayscale and color images, refer to “Changing the Default Media Type and Size” on page 8-3.
- Use a Job Settings file that specifies the media type/size that you want to print to. For more information on Job Settings files, refer to the next topic.

Using Job Settings Files with DICOM

Typically, you will be able to specify any needed print job setting from within your DICOM user application (for example, the media type and size, or the contrast setting for an image). However, it is possible that there is a job setting supported by the Horizon imager that cannot be specified in your DICOM application. Using the Horizon imager's *Job Settings* feature, you can work around this limitation.

The Horizon imager supports multiple Job Settings files, each of which can define unique sets of sheet and image settings. A Job Settings file can specify values for each of the Horizon sheet and image settings, or only a subset of those settings.

For example, say your DICOM application does not support specifying the media type and size. A Horizon Job Settings file that does specify a particular type and size can be used to perform this function.

Categories of Job Settings

There are two categories of Job Settings:

- **System Job Settings.** These Job Settings files come preconfigured in the Horizon imager. They include a job setting for each media type and size combination, for the three receive trays, and for the three job priorities. For a complete list of the system Job Settings files, refer to Appendix C.
- **Custom Job Settings.** These Job Settings files are created at the user site. They can be created at the control panel, or by sending an ASCII text file that includes the settings and their values to the Horizon imager via FTP or LPR protocols. The procedures for creating custom Job Settings files are described in the *Horizon Imager Technical Manual*.

Specifying a Job Settings File from a DICOM User Application

You may see several destination imager devices in your DICOM application, all of which actually print to the same Horizon imager. They just represent different Job Settings files, each assigned its own Called AE Title, so that you can use various job settings that are supported by the imager but that you cannot specify from within the application's standard interface.

For example, the system Job Settings file that specifies **DirectVista** 8 x 10 blue film is **8x10-dvfb**. To specify **DirectVista** 8 x 10 blue film for a print job, the DICOM user application would use **8x10-dvfb** as the Called AE Title when starting a Print Service Class session with the Horizon imager. The Horizon imager, knowing that its DICOM print service was requested using the Called AE Title **8x10-dvfb**, would look in the Job Settings file named **8x10-dvfb** to see which sheet and image settings should be applied to the print job (in this case, only the media type and size).

The Horizon imager also supports being assigned multiple IP addresses for some systems that do not support configuring more than one printer per IP address. For more information about multiple IP addresses and how DICOM printing to the Horizon imager can be implemented, refer to the *Horizon Imager Technical Manual*.

Hierarchy of Settings Used by the Horizon Imager

For DICOM print jobs, the Horizon Imager uses the following sequence to determine the values for sheet and image settings to use when printing a sheet:

1. Looks in the specified Job Settings file.
2. For any sheet or image settings not specified in the Job Settings file, looks in the DICOM print session information (for settings defined within the DICOM user application).
3. For any sheet or image settings not specified in the Job Settings file or DICOM print session information, uses the imager's default settings. For more information about the imager's default settings, refer to Chapter 8.

For more information on the hierarchy of settings, refer to the Horizon imager's DICOM Conformance Statement, and to the *Horizon Imager Technical Manual*.

6

Printing via PostScript

The printing procedures covered in this chapter assume that:

- The PostScript support option is installed in your Horizon imager.
- The Horizon imager has been configured as a Windows or Macintosh desktop printer on your workstation using the Horizon PostScript print driver.
- You are sending print jobs from a Windows (Windows 98, Me, NT 4.0, 2000, or XP) or Macintosh (OS 8, 9, or X) application.
- You are familiar, in general, with how to print from Windows or Macintosh applications to a desktop printer.

Complete instructions for adding a Horizon imager as a desktop printer are provided in the Horizon PostScript Driver Technical Briefs, available in PDF format on the Horizon PostScript Drivers CD-ROM.

For sending PostScript files from UNIX or Linux, refer to the *Horizon Imager Technical Manual*.

Introduction to PostScript

PostScript printing technology was developed to provide consistent, predictable printing from every major computer platform to any printing device that supports it.

PostScript is software that tells an output device, such as a printer, how to print fonts and graphic elements on a page. As such, it acts as a translation program between a workstation application and the printer.

The basic workflow of a PostScript print job is as follows:

1. When you execute the Print function from within your workstation application, a PostScript print driver creates a PostScript language file.

This file contains PostScript commands that describe the page to be printed, the size and style of fonts and graphics, where they should be placed on the page, and color information.

2. The PostScript language file is sent to the output device.
3. A raster image processor (RIP) in the output device processes the file, translating the commands into an array of pixels—referred to as a *raster image*—that recreate the intended image of the entire page.
4. The raster image data is sent to the device's print engine, which in turn prints the pixels on the page media.

There have been three PostScript technologies released since its inception—levels 1, 2, and, the most recent version, 3. The Horizon imager supports all three levels.

Hierarchy of Parameter Settings Used by the Horizon Imager

For PostScript print jobs, the Horizon Imager uses the following sequence to determine the values for sheet and image parameters to use when printing a sheet:

1. Uses the parameter settings in the PostScript print job information.
2. For any sheet or image parameters not specified in the PostScript print job information, uses the imager's default settings for those parameters. For more information about the imager's default settings, refer to Chapter 8.



NOTE: You can access any of the Horizon imager's sheet and image parameters from a Windows or Macintosh application when sending a print job. Therefore, using Job Settings files with PostScript is not necessary and so is not supported.

Specifying the Media Type and Size

When sending a print job via PostScript, you specify the media size and type using PostScript parameters. How you access these parameters, and what their defaults are set to, differ depending on which operating system you are using. For more information, refer to the appropriate topic in this chapter.

Printing from Windows Applications

Once the Horizon imager is set up as a Windows printer on your workstation (which is described in several Horizon PostScript Technical Briefs, one for each type of Windows system), you can send images to it for printing from any Windows application.

Typically, when you invoke the Print function from within the application, a Print dialog box displays. From this dialog box, you can select the Horizon imager as the print destination, if it has not already been set as your default printer.

Specifying Horizon PostScript Parameters

When the Horizon imager is added as a Windows printer, a default set of print job, sheet, and image parameter settings is defined for it. However, from the Print dialog box, you can change any of the parameters' settings. Table 6-1 on page 6-6 describes each of the Horizon PostScript parameters that can be changed. For more information about print job, sheet, and image parameters, refer to Appendix D and to the *Horizon Imager Technical Manual*.

For instructions about how to change Horizon PostScript parameter settings:

- *For Windows 98 and Me*, refer to “Changing Horizon PostScript Parameters—Windows 98 and Me” on page 6-9.
- *For Windows NT*, refer to “Changing Horizon PostScript Parameters—Windows NT” on page 6-12.
- *For Windows 2000 and XP*, refer to “Changing Horizon PostScript Parameters—Windows 2000 and XP” on page 6-15.

Notes About Changing PostScript Parameters

- There are other, non-Horizon-related parameters included in the set of available PostScript print parameters. Because unpredictable results may occur, it is recommended that you change the defaults for only those Horizon imager parameters listed in Table 6-1 on page 6-6.
- Some of the “Allowed Values” shown in Table 6-1 may depend on available imager options and thus may not appear on some systems.
- Settings made at print time via the Print dialog boxes will take precedence over settings made at the imager. Note, however, that the **Use Printer Default** or **Use Current Setting in the Printer** setting can be chosen for many of the parameters in the Print dialog box.

Table 6-1. Horizon Imager Windows PostScript Parameters

Parameters	Settings	Description
Page (Paper) Size	HZ-8x10_DVpaper HZ-A_DVpaper HZ-A4_DVpaper HZ-11x14_DVpaper HZ-14x17_DVpaper HZ-8x10_DVfilm_blue HZ-11x14_DVfilm_blue HZ-14x17_DVfilm_blue HZ-8x10_DVfilm_clear HZ-11x14_DVfilm_clear HZ-14x17_DVfilm_clear HZ-8x10_CVpaper HZ-A_CVpaper HZ-A4_CVpaper	Specifies the Horizon media type and size to use. Use one of the Horizon page sizes. Avoid using non-Horizon paper sizes and special types, such as Letter , as these may give unpredictable results.
Output Bin	Upper, Middle, Lower	Specifies which receive tray to use. Corresponds to the imager's Receive Tray job parameter.
Orientation	Portrait or Landscape	Determines whether images print vertically (portrait) or horizontally (landscape) on the sheet. Do not use Rotated if available as a choice.
Copy Count	1 to 99	Multiple copies can be printed. You may want to reset this back to 1 after the current printing.
Driver Version	Current driver version	This parameter cannot be changed. It is always set to the current driver version number.
Sheet Layout	Unscaled, Scaled, GCS (or GCT) Bracket, MCM Bracket	Specifies whether the image will be scaled or not, or whether to print a bracketing sheet. Use Unscaled to print the image at original size. Use Scaled to print the image scaled to the media size. For information about the bracketing sheets, refer to Chapter 9.
Antialias	None, Better, Best	None—no antialiasing is performed. Better—a compromise between antialiasing quality and print speed. Best—highest antialiasing quality, but requires the most processing time.

Table 6-1. Horizon Imager Windows PostScript Parameters (cont.)

Parameters	Settings	Description
Crop Margin	True, False	Eliminates white margin around region of interest. Advanced feature. Refer to the <i>Horizon Imager Technical Manual</i> for more information.
Margin Size	0 to 50 (pixels), in increments of 5	Works with Crop Margin to create small border around region of interest. Advanced feature. Refer to the <i>Horizon Imager Technical Manual</i> for more information.
Print FMF After Job	True, False	Not currently implemented. Always select Use Printer Default.
Skip Blank Pages	True, False	Prevents printing of a sheet or cell if blank.
Gamma	0.1 to 6.0	Affects image brightness.
Contrast	-100 to 100	Affects image contrast.
Polarity	Positive or Negative	Can be used to reverse image polarity.
Background	White/Clear, Light, Medium, Dark, Black	Sets color of any part of sheet or cell not covered by an image.
Scaling Method	Box, Bilinear, Mitchell, Bicubic, Lanczos, Sharp1, Sharp2, Sharp3	Specifies the filter to use if the image is being scaled (scaling can be specified in the Sheet Layout parameter in Set 1).
Saturation	-100 to 100, in increments of 5	A property of color that specifies how far a color is from a gray tone of the same density. Negative values reduce saturation; positive values increase saturation. -100 = no color; 0 = no adjustment; 100 = full color.
MCM	0 to 17, plus other custom values	Medical Color Matching. For values 1 through 17, algorithms are applied to the image data before printing so that printed images match those displayed on a monitor. For a list of which monitors correspond to the available MCM values, refer to Appendix D.
Dmax	100 to 400, in increments of 10	Maximum image density value.
Dmin	0 to 100, in increments of 10	Minimum image density value.

Table 6-1. Horizon Imager Windows PostScript Parameters (cont.)

Parameters	Settings	Description
Sheet Coverage	Standard, NP, or Fullbleed	Corresponds to the imager's Coverage sheet parameter. Determines whether there will be a border between images and edges of the sheet, or images will bleed off the sheet edges. <i>Advanced parameter. Refer to the <i>Horizon Imager Technical Manual</i> for more information.</i>
Film View	Front, Back	The direction from which the film is viewed once printed.
LUT Type	Visual, Linear, or Custom1 through Custom8	Look-up table. Customized data curves that affect an image's appearance. <i>Advanced parameter. Refer to the <i>Horizon Imager Technical Manual</i> for more information.</i>
Border Fill	True, False	Sets color of area around active print area of sheet. <i>Advanced parameter. Refer to the <i>Horizon Imager Technical Manual</i> for more information.</i>
Captions	True, False	Enables or disables captions, if any have been set up on the imager. Note that captions cannot be set up via PostScript. <i>For information about how to set up captions, refer to the <i>Horizon Imager Technical Manual</i>.</i>
Image Warnings	True, False	Enables or disables the warning message included on a sheet if a printed image is decimated.
Priority	Low, Medium, High	Priority of job sent to imager. Higher priority jobs are printed first.

Changing Horizon PostScript Parameters—Windows 98 and Me



NOTE: This procedure assumes that the PostScript driver for the Horizon imager has already been installed on the workstation. For more information, refer to the “Windows 98 Driver Installation—Horizon” or “Windows Me Driver Installation—Horizon” Technical Brief.



To change the PostScript parameters in Windows 98 or Me

1. Initiate the print job from the Windows application.

The Print dialog box displays.

2. Make sure that the Horizon imager is the selected printer.
3. Click the **Properties** button.

The Properties dialog box displays.



4. To specify the media size and type combination, go to the Paper tab and select one of the Horizon paper/white film choices. The Horizon media choices begin with “HZ.”

- To specify an output bin, click the **More Options** button.
The More Options dialog box displays.



- Select the output bin, or use the printer default, then click **OK**.
- To specify any of the other Horizon PostScript settings, go to the Device Options tab.

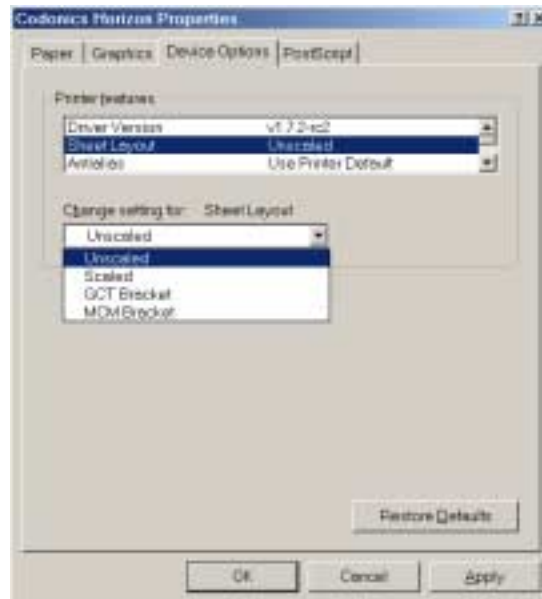

8. To change a parameter's setting, select the parameter from the **Printer Features** list.

The available choices are listed in the **Change setting for** drop-down list.

9. Select the desired setting from the **Change setting for** list.
10. When you are done changing settings, click **OK** to save your changes.

The settings you have saved will be in effect for the current session of the application from which you are printing. If you open a new session of the application or print from a different application, the parameters revert to their default settings.

Changing Horizon PostScript Parameters—Windows NT



NOTE: This procedure assumes that the PostScript driver for the Horizon imager has already been installed on the workstation. For more information, refer to the “Windows NT Driver Installation—Horizon” Technical Brief.



To change the PostScript parameters in Windows NT

1. Initiate the print job from the Windows application.

The Print dialog box displays.

2. Make sure that the Horizon imager is the selected printer.
3. Click the **Properties** button.

The Document Properties dialog box displays, with the Page Setup tab selected.



4. To specify the media size and type combination, select one of the Horizon paper/white film choices from the **Paper Size** drop-down list. The Horizon media choices begin with “HZ.”

5. To specify any of the other Horizon PostScript settings, go to the Advanced Settings tab.



Note that you can also select the Horizon media from the **Paper Size** option on the Advanced Settings tab.

6. Scroll down to the **Printer Features** list.

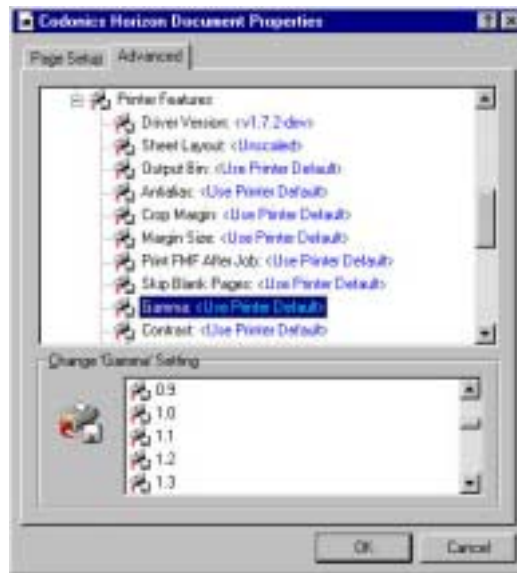

7. To change a parameter's setting, select the parameter from the **Printer Features** list.

The available settings are listed in the **Change Setting** list.

8. Select the desired setting from the **Change Setting** list.
9. When you are done changing settings, click **OK** to save your changes.

The settings you have saved will be in effect for the current session of the application from which you are printing. If you open a new session of the application or print from a different application, the parameters revert to their default settings.

Changing Horizon PostScript Parameters—Windows 2000 and XP



NOTE: This procedure assumes that the PostScript driver for the Horizon imager has already been installed on the workstation. For more information, refer to the “Windows 2000 Driver Installation—Horizon” or “Windows XP Driver Installation—Horizon” Technical Brief.



To change the PostScript parameters in Windows 2000 and XP

1. Initiate the print job from the Windows application.

The Print dialog box displays.

2. Make sure that the Horizon imager is the selected printer.
3. Click the **Properties** button.

The Document Properties dialog box displays.

4. Click the **Advanced** button.

The Advanced Options dialog box displays.

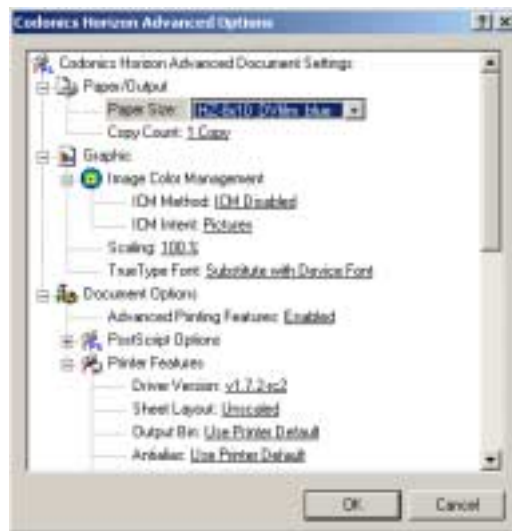

5. Specify a Horizon media size and type combination from the **Paper Size** drop-down list. The Horizon media choices begin with “HZ.”
6. To specify any of the other Horizon PostScript parameter settings, scroll to the **Printer Features** list of parameters.

7. When you are done changing settings, click **OK** to save your changes.

The settings you have saved will be in effect for the current session of the application from which you are printing. If you open a new session of the application or print from a different application, the parameters revert to their default settings.

Printing from Macintosh Applications

Once the Horizon imager is set up as a printer on your Macintosh (which is described in the two *Macintosh Driver Installation—Horizon* Technical Briefs, one for OS 8 and 9 and one for OS X), you can send images to it for printing from any Macintosh application.

To print to the Horizon imager, you first use the application's Page Setup function to select the Horizon media size and type. Then, you use the standard Print dialog box to select the Horizon imager as the print destination and set the Horizon PostScript parameters.

Specifying the Horizon Media

Before sending a print job to the Horizon imager, you must select the Horizon media size and type using the application's Page Setup function. The available choices are listed in Table 6-2 on page 6-21.

Examples of the Page Setup dialog box are shown below. Select from the Horizon media size and type combinations in the **Paper Size** (OS X) or **Paper** (OS 8 and 9) pop-up menu.

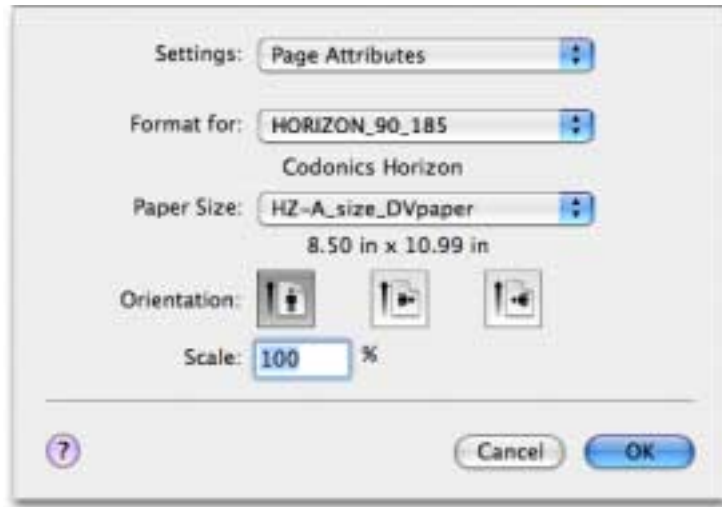

Page Setup Dialog Box—OS X

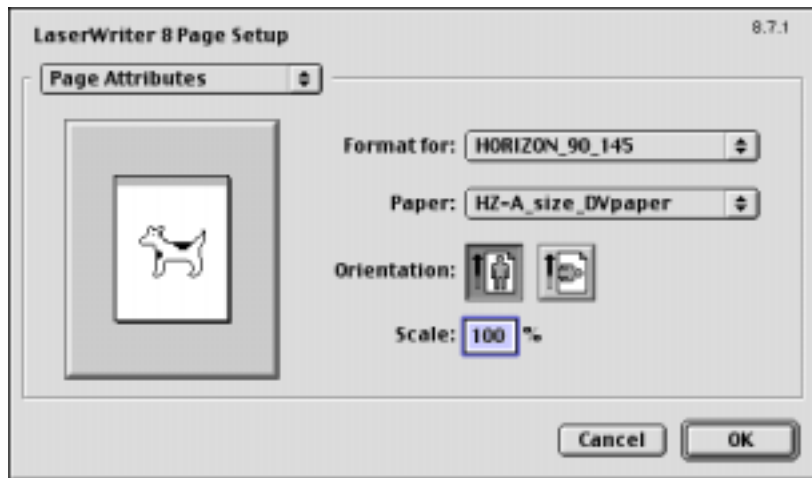

Page Setup Dialog Box—OS 8 and 9

Specifying Horizon PostScript Parameters

When printing from a Macintosh application, the Horizon-specific PostScript print parameters are available from:

- For OS X, the **Printer Features** panel in the Print dialog box. Note that you may have to click an **Advanced** button on the Print dialog box to access the **Printer Features** panel. Different groups of parameters are displayed, depending on what is selected in the **Feature Sets** pop-up menu.



- For OS 8 and 9, the Print dialog box will include a **Features** button, **Printer Specific Options** pop-up menu selection (shown below), or other method for choosing the Horizon-related parameter settings.

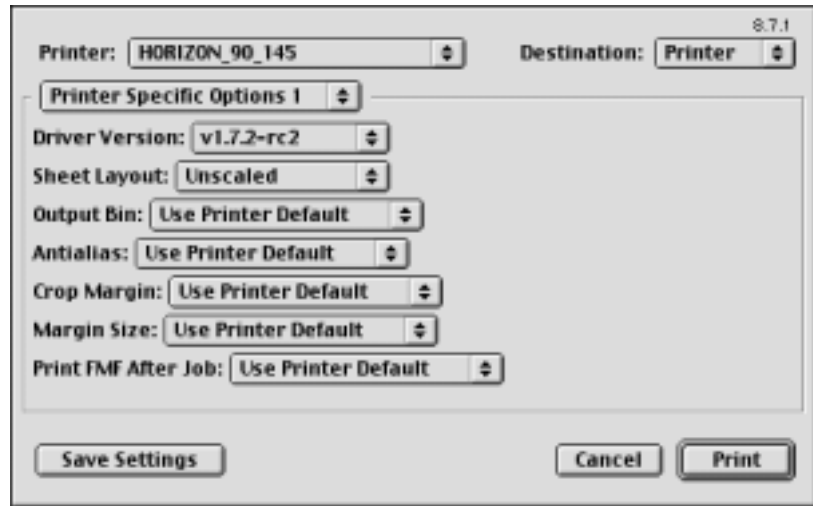

Depending on the application from which you are printing, the print parameters may be organized as print job, sheet, and image sets. Table 6-2 on page 6-21 describes each of the parameters. For additional information about Horizon print parameters, refer to Appendix D and to the *Horizon Imager Technical Manual*.

Notes About Changing PostScript Parameters

- There are other, non-Horizon-related parameters included in the set of available PostScript printer parameters. Because unpredictable results may occur, it is recommended that you change the defaults for only those Horizon imager parameters listed in Table 6-2 on page 6-21.
- Some of the “Selectable Values” shown in Table 6-2 may depend on available Horizon imager options and thus may not appear on some systems.
- Settings made at print time via the Print dialog boxes will take precedence over settings made at the imager. Note, however, that a “Use Printer Default” setting can be chosen for many of the parameters in the Print dialog box. Note that the exact wording of the “Use Printer Default” setting can vary depending on which Macintosh OS and application you are using.

Table 6-2. Horizon Imager Macintosh PostScript Parameters

Parameters	Settings	Description
Paper Size Settings (Page Setup dialog box)		
Paper Size	HZ-8x10_DVpaper HZ-A_DVpaper HZ-A4_DVpaper HZ-11x14_DVpaper HZ-14x17_DVpaper HZ-8x10_DVfilm_blue HZ-11x14_DVfilm_blue HZ-14x17_DVfilm_blue HZ-8x10_DVfilm_clear HZ-11x14_DVfilm_clear HZ-14x17_DVfilm_clear HZ-8x10_CVpaper HZ-A_CVpaper HZ-A4_CVpaper	Specifies the Horizon media type and size to use. Use one of the Horizon page sizes. Avoid using non-Horizon paper sizes and special types, such as Letter , as these may give unpredictable results.
Print Job Settings (Print dialog box: OS X—Sets 1 and 2; OS 8 & 9—Printer Specific Options)		
Output Bin	Upper, Middle, Lower	Specifies which receive tray to use.
Driver Version	Current driver version	This parameter cannot be changed. It is always set to the current driver version number.
Sheet Layout	Unscaled, Scaled, GCS (or GCT) Bracket, MCM Bracket	Specifies whether the image will be scaled or not, or whether to print a bracketing sheet. Use Unscaled to print the image at original size. Use Scaled to print the image scaled to the media size. For information about the bracketing sheets, refer to Chapter 9.
Antialias	None, Better, Best	None—no antialiasing is performed. Better—a compromise between antialiasing quality and print speed. Best—highest antialiasing quality, but requires the most processing time.
Crop Margin	Yes, No	Eliminates white margin around region of interest. Advanced feature. Refer to the <i>Horizon Imager Technical Manual</i> for more information.

Table 6-2. Horizon Imager Macintosh PostScript Parameters (cont.)

Parameters	Settings	Description
Margin Size	0 to 50 (pixels), in increments of 5	Works with Crop Margin to create small border around region of interest. Advanced feature. Refer to the <i>Horizon Imager Technical Manual</i> for more information.
Print FMF After Job	Yes, No	Not currently implemented. Always select Use Printer Default.
Skip Blank Pages	Yes, No	Prevents printing of a sheet or cell if blank.
Sheet Settings (Print dialog box)		
Dmax	100 to 400, in increments of 10	Maximum image density value.
Dmin	0 to 100, in increments of 10	Minimum image density value.
Sheet Coverage	Standard, NP, or Fullbleed	Corresponds to the imager's Coverage sheet parameter. Determines whether there will be a border between images and edges of the sheet, or images will bleed off the sheet edges. Advanced parameter. Refer to the <i>Horizon Imager Technical Manual</i> for more information.
Film View	Front, Back	The direction from which the film is viewed once printed.
Lut Type	Visual, Linear, or Custom1 through Custom8	Look-up table. Customized data curves that affect an image's appearance. Advanced parameter. Refer to the <i>Horizon Imager Technical Manual</i> for more information.
Border Fill	Yes, No	Sets color of area around active print area of sheet. Advanced parameter. Refer to the <i>Horizon Imager Technical Manual</i> for more information.
Captions	Yes, No	Enables or disables captions, if any have been set up on the imager. Note that captions cannot be set up via PostScript. For information about how to set up captions, refer to the <i>Horizon Imager Technical Manual</i> .
Image Warnings	Yes, No	Enables or disables the warning message included on a sheet if a printed image is decimated.

Table 6-2. Horizon Imager Macintosh PostScript Parameters (cont.)

Parameters	Settings	Description
Priority	Low, Medium, High	Priority of job sent to imager. Higher priority jobs are printed first.
Image Settings (Print dialog box)		
Gamma	0.1 to 6.0, in increments of 0.5	Affects image brightness.
Contrast	-100 to 100, in increments of 5	Affects image contrast.
Polarity	Positive, Negative	Can be used to reverse image polarity.
Background	White/Clear, Light, Medium, Dark, Black	Sets color of any part of sheet or cell not covered by an image.
Scaling Method	Box, Bilinear, Mitchell, Bicubic, Lanczos, Sharp1, Sharp2, Sharp3	Specifies the filter to use if the image is being scaled (scaling can be specified in the Sheet Layout parameter in Set 1).
Saturation	-100 to 100, in increments of 5	A property of color that specifies how far a color is from a gray tone of the same density. Negative values reduce saturation; positive values increase saturation. -100 = no color; 0 = no adjustment; 100 = full color.
MCM	0 to 17, plus other custom values	Medical Color Matching. For values 1 through 17, algorithms are applied to the image data before printing so that printed images match those displayed on a monitor. For a list of which monitors correspond to the available MCM values, refer to Appendix D.

Saving Horizon Print Settings as Presets in OS X

A standard OS X Print feature is the ability to save the current parameter settings in the Print dialog box as a *preset*. This allows you to choose from a list of presets to automatically select common combinations of print parameter settings. The presets are accessible from any OS X application.

So, for example, you can use the Preset function to save a preset for each combination of Horizon PostScript print settings that you commonly use.

To save the current settings as a preset, select **Save As** from the **Presets** pop-up menu, and name the preset.

The next time you want to use that combination of settings, you can simply choose its preset from the **Presets** pop-up menu. You can also then change any of that preset's default settings, as necessary for that particular print job.

Saving Horizon Print Settings in OS 8 and 9

A standard OS 8 and 9 Print feature is the ability to save the current parameter settings in the Print dialog box.

The exact method used differs from application to application. With some applications, the most recently used print parameter settings are saved automatically with the file when the file is saved. With other applications, a **Save Settings** button may be included on the Print Dialog box to allow you to save the current settings as the defaults for any file opened in the application. Refer to your application's documentation for further details.

7

Printing via FTP and LPR

Support for receiving print jobs via FTP and LPR comes standard with the imager. FTP and LPR are advanced methods for sending print jobs, typically used by system integrators. This chapter provides basic instructions for sending print jobs via FTP and LPR. However, for a complete explanation about how to use these methods, refer to the *Horizon Imager Technical Manual*.

Printing via FTP

FTP (File Transfer Protocol) is a protocol that enables you to login to the Horizon imager from your workstation and send image files to be printed. You can also send text files containing custom commands and parameters used to set up your sheets and process the images.

FTP uses the TCP/IP networking protocol and is available for most computer platforms, including UNIX, Linux, MS-DOS/Windows, and Macintosh.

The procedure that follows explains how to FTP image files from a command window on your workstation. If you are using a GUI-based FTP application, you will likely click buttons and drag files from one window to another instead of entering commands.

While the user interface may vary between implementations of FTP, the information required to connect to the imager and send files is the same.

To print a sheet, you simply start an FTP session with the imager, login to the FTP session using a logical device as the password to indicate what format to use, then send one or more images to be printed on the sheet.



To print a sheet
using FTP

1. From your workstation, open a command window.
2. To start the FTP session, at the command prompt enter the following command:

```
ftp x.x.x.x
```

where *x.x.x.x* is the IP address of the Horizon imager to which you want to send the print job.



NOTE: If you have configured a host alias for the Horizon imager on your workstation or you are using Domain Name Service (DNS), you can enter the imager's host name instead of the IP address.

FTP connects with the imager and you are prompted to log in.

3. Enter a name to identify yourself to the Horizon imager.



NOTE: The Horizon imager does not maintain FTP user accounts, so you can really enter any name you want. However, the imager does track print jobs by the source user login/host. Therefore, it is recommended that you use a name that is unique among other users of the imager. This will also allow you to identify your jobs in the imager's log information.

You are prompted for a password.

4. At the password prompt, you need to enter the Horizon logical device number that represents the sheet format you want to use:
 - **To print a single image**, enter **1** (unscaled) or **2** (scaled).

- **To print multiple images on a sheet using Fixed Multiformating™ (FMF™)**, enter the number from **11** to **99** that corresponds to the sheet format you want to use. The first digit in the logical device specifies the number of columns in the image cell matrix, and the second digit specifies the number of rows.

For example, logical device **12** corresponds to a 1 x 2-image sheet (one image stacked on another); logical device **23** corresponds to a 2 x 3-image sheet (6-up format—2 columns by 3 rows). For more information about FMF, refer to the *Horizon Imager Technical Manual*.

- **To specify a Job Settings file**, append a period (.) and the Job Settings file name after the logical device number. For example:

```
23.MYSETTINGS1
```

After entering the logical device number at the password prompt, you are logged in to an FTP session on the imager.

5. Specify that you want to transfer files in *binary* mode by entering the following command (on some systems, binary mode is called *image* mode):

```
ftp> bin
```

You can now begin transferring image files to the imager.

6. Use the **put** command to send one or more images to the imager; for example:

```
ftp> put image1.tif
ftp> put image2.tif
```

7. You can also specify multiple files in one **mput** command. Before entering the **mput** command, you can turn off its confirmation prompting prior to sending each file by first entering the **prompt** command:

```
ftp> prompt
ftp> mput image1.tif image2.tif
```

Multiple files are placed sequentially in the cells on the sheet, moving from left to right, top to bottom. When you send enough images to fill the selected sheet format, the sheet is automatically printed. (To toggle file confirmation back on, simply enter the **prompt** command again.)



NOTE: To force a sheet that is not full of images to print, create an ASCII text file whose content is simply the word `print`. (It does not matter what you call the file, or whether `print` is in upper or lower case letters.) Then use the **put** command to send the text file to the imager.

8. To send another print job using the same sheet format, use the **put** command to send the image(s) to the imager.
9. When you are finished sending images to be printed and want to close the FTP session, enter `quit`.

There are some other common operations that you may want to perform during an FTP session. For complete information about how to send print jobs using FTP, refer to the *Horizon Imager Technical Manual*.

Specifying the Media Type and Size Using FTP

To set the media type and size to use for a given print job using FTP, you have two options:

- Simply send the print job. The Horizon imager can determine whether the image is grayscale or color. The imager will then use the default media type/size defined for that image type. For more information about how to define the default media type/size to use for grayscale and color images, refer to “Changing the Default Media Type and Size” on page 8-3.
- Use a Job Settings file that specifies the media type/size that you want to print to. For more information on Job Settings files, refer to the *Horizon Imager Technical Manual*.

Printing via LPR

LPR (originally named for *line printer*) is a printing tool that enables you to send files to the Horizon imager.

LPR uses the TCP/IP networking protocol and is most commonly used in UNIX and Linux, and to a lesser extent in Windows and other operating systems. Most LPR implementations have easy-to-use commands for sending files to the imager. However, they do require setup by a system administrator for correct operation. Instructions for setting up LPR to work with the Horizon imager are provided in the *Horizon Imager Technical Manual*.

To print jobs to the Horizon imager using LPR, use the **lpr** command as follows:

```
lpr -Pname [-#c] [-s] imagefile1 [imagefile2] ...
```

where:

-Pname is the name for the Horizon imager logical device/Job Settings file combination that you want to use.

The names for the available combinations are typically defined by a system administrator during LPR setup.

-#c is a command option that allows you to specify the number of copies, *c*, to print. If not defined, one sheet will be printed.

-s is a command option that causes LPR to send the images directly to the Horizon imager, and not store them temporarily in the spool directory. This option can save printing time. If used, you cannot delete the image file being sent until it is finished printing.

imagefiles are the image files to be printed on the sheet. Image cells are filled left to right, top to bottom.

Examples of Printing Using LPR

For the first example, assume that the LPR printer **horizon2** has been configured to print 1-up scaled image sheets using the imager's Default User Settings (that is, no Job Settings file has been specified in the printer's configuration). To print 3 copies of a single scaled image called **image.tif**, you would enter:

```
lpr -Phorizon2 -#3 image.tif
```

For the second example, assume that the LPR printer **horizon23MJS4** has been configured to print 6-up FMF sheets using the Job Settings file **MYSETTINGS4**. To print 1 copy of 6 JPEG image files without spooling the image files, you would enter:

```
lpr -Phorizon23MJS4 -s image1.jpg image2.jpg ...  
image6.jpg
```

There are some other common operations that you may want to perform using the LPR. For complete information about how to send print jobs using LPR, refer to the *Horizon Imager Technical Manual*.

Specifying the Media Type and Size Using LPR

To set the media type and size to use for a given print job using LPR, you have two options:

- Simply send the print job. The Horizon imager will determine whether the image is grayscale or color. The imager will then use the default media type/size defined for that image type. For more information about how to define the default media type/size to use for grayscale and color images, refer to "Changing the Default Media Type and Size" on page 8-3.
- Use a Job Settings file that specifies the media type/size on which you want to print. For more information on Job Settings files, refer to the *Horizon Imager Technical Manual*.

8

Default Print Job Settings

Every print job has parameters associated with it that control how the job is to be processed (for example, media size and type, scaling, gamma, contrast, and so on).

The Horizon imager has a complete set of *default settings* that contain values for every media type/size, sheet, and image parameter of a print job. The default settings are stored in the imager and can be viewed and changed through the control panel. Once changed, you can also change back to the original factory-default settings at any time.

If a print job parameter has not been defined from within the sending user application, in a selected Job Settings file, or in a Zip disk **settings.txt** file, the imager's Default Media and Default User Settings are used.



CAUTION Use caution when changing the imager default settings. Changes could affect prints made by other users.

Refer to Appendix D for a summary of the print job parameters that can be changed at the control panel. Note that many of these parameters require a good understanding of what effect changing the parameter's setting will have on printed images and sheets. For a full discussion of each parameter, refer to the *Horizon Imager Technical Manual*. You can also refer to the Technical Manual for information about using Job Settings files and printing files automatically from a Zip disk.

Changing Default Settings

If the factory-default settings do not meet your printing requirements, you can change parameter settings at the control panel. You can change the:

- Default **media** to use for grayscale or color images
- Default **sheet and image parameter settings** (referred to in the administrative Main Menu as the “Default User Settings”) for each media type

Changing the default settings overrides the factory defaults, but does not delete them. You can easily reset the factory defaults at any time. For more information, refer to “Resetting to Factory-Default Settings” on page 8-7.



NOTE: Changes to the default settings apply only to new incoming print jobs. Jobs already queued for printing are printed using the default settings that were in effect when the print job was received.



CAUTION Changing the default settings will affect prints made by other users. Use caution when changing default settings. Typically, it is better to specify sheet and image parameter settings from the DICOM application or a PostScript printer’s settings, or use a Job Settings file that contains the values you need. For information about Job Settings files, refer to the *Horizon Imager Technical Manual*.

Changing the Default Media Type and Size

Media refers to the various types and sizes of Horizon film and paper/white film. One default media is specified for grayscale images, and one for color images.

When the imager receives a grayscale image, it prints the image to the default grayscale media type and size, unless otherwise specified. Likewise, when the imager receives a color image, it prints the image to the default color media type and size.



To change the default media

1. At the control panel, press the  key.
The Main Menu displays.
2. Select the following menu options, based on the type of image being sent for printing:

Default Media
Grayscale
or
Color

The media types display.

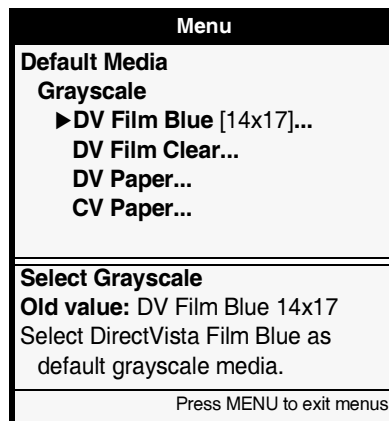

3. Select the media type you want to use as the default.

The various sheet sizes for that media type are displayed. The current default value is enclosed in square *change* brackets. For example, selecting DV Film Blue displays the list of sheet sizes shown below. The currently selected default size is 14 x 17 in.

Menu

Default Media

Grayscale

DV Film Blue

8x10

[14x17]

Select DV Film Blue size

Old value: 14x17

Press MENU to exit menus

4. Use the ▲ and ▼ keys to move the change brackets to the desired sheet size, then press the **ENTER** key to save the change. The default media is changed for the print output you selected (grayscale or color).
5. Repeat the procedure, as needed, to change the default media for the other type of print output (grayscale or color).



NOTE: You could select a **DirectVista** grayscale media as the default media for color images. For example, if your imager does not support **ChromaVista** color media, you would choose a **DirectVista** media as the default media for color images. Likewise, you could select a **ChromaVista** color media as the default media for grayscale images.

Changing Default User Settings for a Media Type

You can change the Default User Settings (that is, the default sheet and image parameter settings) for each available media type supported by your imager.



To change
Default User
Settings for a
media type

1. At the imager's control panel, press and hold the  key, and while holding it press the  key.

The Main Menu with administrative options displays.

2. Select the **Default User Settings** option, then one of the following media types:

- DV Film Blue
- DV Film Clear
- DV Paper
- CV Paper

The current parameter settings are displayed for that media type. For example, selecting **DV Film Blue** displays the following list of parameters and their current settings. In this example, the current default value for Gamma is 1.0.

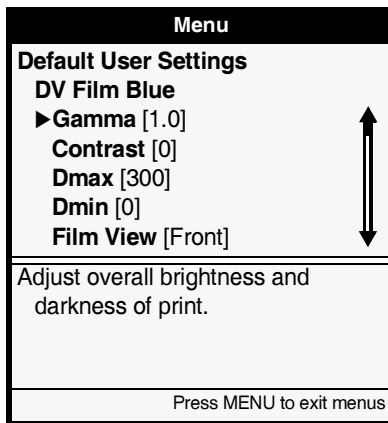

NOTE: For information about the parameters and their possible settings, refer to Appendix D or to the Horizon Imager Technical Manual.

3. Scroll through the parameters for this media type, and change the default settings, as needed.

For example, to change the Gamma default setting, select the **Gamma** menu entry and then, in the **Gamma** setting menu, use the ▲ and ▼ keys to enter a new value inside the change brackets.

4. Repeat the procedure, as needed, to change the default settings for other media types supported by your imager.

Resetting to Factory-Default Settings

If you configured your own default settings, you can reset them to the factory defaults at any time.

Resetting to the factory default settings applies only to new incoming print jobs. Jobs already queued for printing are printed using the default settings that were in effect when the print job was received.



CAUTION If the imager's settings were changed from the factory defaults **prior** to being shipped (for example, to accommodate a special OEM configuration), resetting to the factory defaults will not restore the "as shipped" settings. Instead, they will be reset to the standard factory default values.



CAUTION Resetting to the factory defaults will affect prints made by other users. Use caution when changing default settings. Typically, it is better to specify sheet and image parameter settings from the DICOM application or a PostScript printer's settings, or use a Job Settings file that contains the values you need. For information about Job Settings files, refer to the *Horizon Imager Technical Manual*.

Resetting the Default Media Selections

You can reset the Default Media selections for grayscale or color images back to the factory-default selections.



To reset the Default Media selections to their factory defaults

1. At the imager's control panel, press the  key.

The Main Menu displays.

2. Select the following menu options:

Default Media
Reset Default Media

You are prompted to confirm the reset.

3. Respond to the confirmation prompt.

The factory-default selections are restored.

Resetting the Default User Settings

You can reset the Default User Settings for all media types back to the factory-default settings.



To reset the Default User Settings for all media types and sizes to their factory defaults

1. At the imager's control panel, press and hold the  key, and while holding it press the  key.

The Main Menu with administrative options displays.

2. Select the following menu options:

Default User Settings
Reset User Settings

You are prompted to confirm the reset.

3. Respond to the confirmation prompt.

The factory-default settings are restored.

9

Adjusting Image Appearance

You can use the Horizon Bracketing™ function to assist you in determining the gamma, contrast, saturation, and MCM (Medical Color Matching) settings that will result in the desired appearance for printed images.

This chapter explains how to print gamma/contrast/saturation (GCS; for PostScript, referred to as “GCT”) or MCM bracketing sheets via DICOM or PostScript, then how to use the print to select the desired settings. For information about how to print bracketing sheets using FTP or LPR, refer to the *Horizon Imager Technical Manual*.



NOTE: Image parameters—including Dmax, gamma, contrast, saturation, and MCM—are intended to compensate for differences that may occur between image acquisition and image printing. These parameters allow you to adjust the appearance of a printed image so that it is satisfactory for your application. Care should be used when setting these parameters to avoid overcompensation. Refer to Appendix D for typical setting ranges.

ChromaVista and Grayscale Images

DirectVista is optimized for grayscale prints, while **ChromaVista** is optimized for color prints. If **ChromaVista** is not giving you satisfactory results with grayscale images, you may want to consider using **DirectVista** media for those applications.

Guidelines for Viewing Printed Images

For best results when viewing printed images, follow these guidelines:

- Codonics film media is designed to be viewed using a light box suitable for viewing medical diagnostic images.
- Codonics paper/white film media is designed to be viewed under cool-white, fluorescent light. Spectral differences and intensity variations in the viewing light sources can change the apparent color of images printed on paper/white film.

General Bracketing Guidelines

If you plan to use MCM settings, then you should use both GCS and MCM bracketing sheets to determine the combination of settings that result in the desired image appearance.

A general strategy for using both the GCS and MCM bracketing sheets is:

1. If an MCM setting has not been recommended, print an MCM bracketing sheet, using a representative image, and select the MCM setting that provides the best color match to your monitor.
2. After determining the MCM setting, print a gamma/contrast bracketing sheet to fine-tune the overall brightness and contrast of the image. For most applications, the gamma setting will be from 0.90 to 1.25, and the contrast setting will be from 0 to 20.

3. If using **ChromaVista** media, print a gamma/saturation bracketing sheet to determine the saturation setting that provides the best color intensity. For most applications, the saturation setting will be from 0 to 20.
4. Repeat the process to fine-tune the settings.

GCS Bracketing Sheets

A gamma/contrast bracketing sheet includes 20 copies of the same image, with each copy having different gamma and contrast settings. When printing to **ChromaVista** media, a second gamma/saturation bracketing sheet that varies gamma and saturation settings for each image is also printed.

You create a gamma/contrast bracketing sheet by printing a representative image using nominal gamma and contrast settings (for example, the factory defaults). In the printed sheet, the image with the nominal settings is indicated by a gray background. The other versions of the image are created by varying gamma and/or contrast from the nominal settings. The gamma and contrast settings used are overprinted at the top left corner of each image.

Using this print, you can select the image with the best appearance for your application, which in turn indicates the gamma and contrast settings to use to achieve that appearance.

For **ChromaVista** color prints, you can then use the gamma/saturation bracketing sheet to determine the gamma and saturation settings that result in the best color appearance for your application.



NOTE: For optimal image quality, use the typical range of settings described in Appendix D.

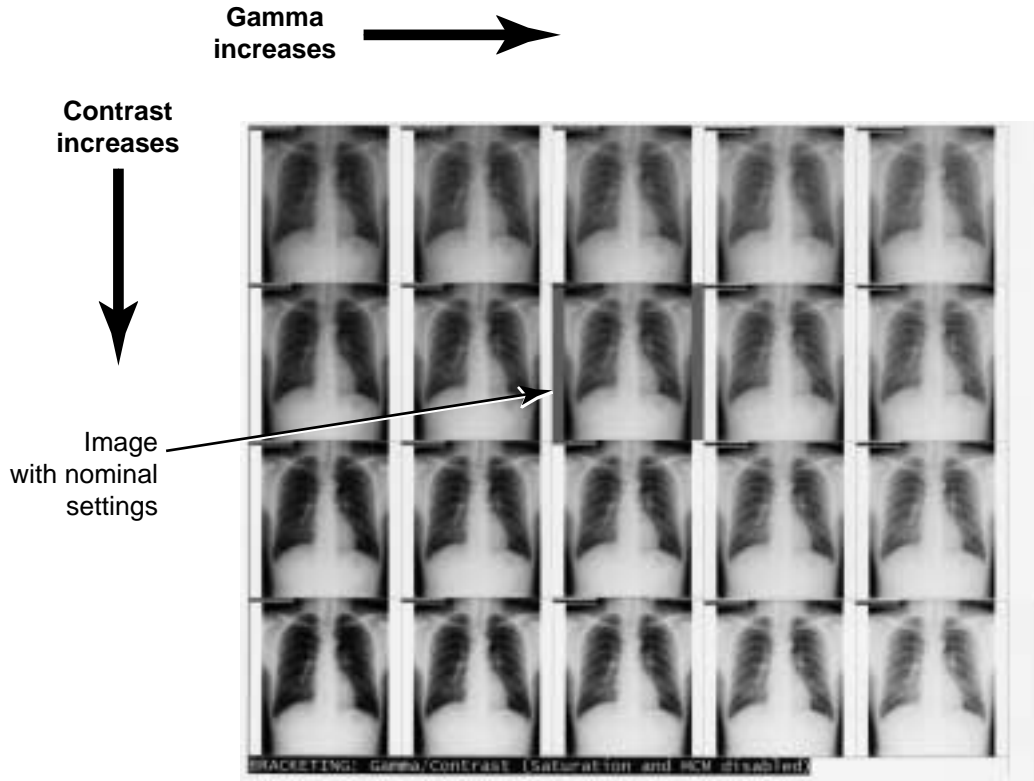

Gamma/Contrast Bracketing Sheet

Printing GCS Bracketing Sheets Using DICOM

To print GCS bracketing sheets from DICOM:

- Use the special Horizon bracketing format, identified by the Called AE Title **SpecialBracket**.

or

- Configure the Image Display Format to **CUSTOM\9** from within your DICOM user application.

If you do not specify the media type and size for the bracketing sheet from within the DICOM user application, then the Horizon imager determines whether the image is grayscale or color. The imager then uses the Default Media defined for that type of image, and the Default User Settings defined for that media type and size. For more information about how to define the Default Media selection and Default User Settings, refer to “Changing the Default Media Type and Size” on page 8-3 and “Changing Default User Settings for a Media Type” on page 8-5.

Once a bracketing sheet is printed, you can use it to make the proper image parameter adjustments, which is described in “DirectVista Adjustments” on page 9-5 and “ChromaVista Adjustments” on page 9-7.

Printing GCS Bracketing Sheets Using PostScript

To print GCS bracketing sheets via PostScript, set the Sheet Layout parameter to **GCS (or GCT) Bracket**, and specify the media type/size using the Media Type and Media Size settings. For more information about changing parameter settings when printing via PostScript, refer to Chapter 6.

Once a bracketing sheet is printed, you can use it to make the proper image setting adjustments, which is described in the next topic, “DirectVista Adjustments”, and in “ChromaVista Adjustments” on page 9-7.

DirectVista Adjustments

To find the best gamma and contrast settings for images printed on DirectVista media:

1. ***If printing to film***, select the Dmax value that is consistent with your application.

If printing to paper/white film, go to step 3.



NOTE: Depending on the application, you can change Dmax, gamma, or contrast in the following ways: (1) from the DICOM user application or PostScript printer settings; (2) changing the Default Media and Default User Settings as the imager control panel (refer to Chapter 8); (3) using Job Settings files (refer to the Horizon Imager Technical Manual). Making these changes does not affect jobs already in the print queue.



CAUTION Changing the imager's Default Media and Default User Settings could affect subsequent prints made by other users. Use caution when changing default settings.

2. Make several test prints using an image that is typical for your application, varying Dmax for each print.

When the blackest part of the image is black enough, stop and go to the next step. Otherwise, adjust Dmax and make another print.

3. Print the image as a gamma/contrast bracketing sheet job for gamma and contrast.

It is recommended that you use the factory defaults for gamma and contrast when making bracketing sheets. However, you can leave them as is if you have already changed the default settings to preferred values.

4. Examine the bracketing sheet and select the copy with the best appearance.

If none of the copies are satisfactory, reprint the bracketing sheet using the settings of the best copy. Repeat this until one of the image copies is acceptable.

5. Set gamma and contrast to the settings used to create the acceptable image.
6. Send a print job that includes various images that are typical for your application.

Check the appearance of these images and make any necessary fine adjustments to gamma and contrast until the images are acceptable.

7. Once you find the most suitable gamma and contrast settings, you should use them for future print jobs. For example, you should update the imager's Default User Settings and any Job Settings files that you use.
8. Once you have the imager configured as you want it using this procedure, you should save the configuration settings to backup media. For more information about how to save configuration settings, refer to "Saving the Configuration Settings" on page 2-20.

ChromaVista Adjustments

To find the best gamma, contrast, and saturation settings for color images printed on **ChromaVista** media, you:

1. Determine the best gamma and contrast settings, as described in "DirectVista Adjustments" on page 9-5. The only exception is that you can ignore the instructions about finding the setting for Dmax. The Dmax parameter does not apply to color media.
2. Using an image that is typical for your application, print a color image bracketing sheet, using the gamma and contrast settings determined in step 1.
3. Examine the gamma/saturation bracketing sheet and select the copy with the best appearance.

If none of the copies are satisfactory, reprint the bracketing sheet using the settings of the best copy. Repeat this until one of the image copies is acceptable.



NOTE: Depending on the application, you can change gamma or saturation in the following ways: (1) from the DICOM user application or PostScript printer settings; (2) changing the Default Media and Default User Settings as the imager control panel (refer to Chapter 8); (3) using Job Settings files (refer to the Horizon Imager Technical Manual). Making these changes does not affect jobs already in the print queue.



CAUTION Changing the imager's Default Media and Default User Settings could affect subsequent prints made by other users. Use caution when changing default settings.

4. Set gamma and saturation to the settings used to create the acceptable image.
5. Send a print job that includes various images that are typical for your application.

Check the appearance of these images and make any necessary fine adjustments to gamma and saturation until the images are acceptable.

6. Once you find the most suitable gamma and saturation settings, you should use them for future print jobs. For example, you should update the imager's Default User Settings and any Job Settings files that you use.
7. Once you have the imager configured as you want it using this procedure, you should save the configuration settings to backup media. For more information about how to save configuration settings, refer to "Saving the Configuration Settings" on page 2-20.

Guidelines for Selecting Saturation Setting

The default setting **0** is optimized for the smoothest blending of color mapping and grayscale, the maximum number of colors, and accurate sensitometry, but not necessarily for the most vibrant color appearance.

Extra saturation can work well with photographs, as it can make colors look more vibrant. However, be aware that if the saturation setting is too high, the printed image can include artifacts (due to discontinuities in the color mapping).

MCM Bracketing Sheets

Codonics MCM is an advanced image processing feature that adjusts printed output colors to more accurately match monitors. This process corrects differences in hue, saturation, and intensity between the imager and a computer monitor. The MCM parameter determines for which monitor type MCM should be optimized.

An MCM bracketing sheet includes 11 copies of the same image, with each copy using one of the standard MCM settings, 0 through 10. The MCM settings used are overprinted at the top left corner of each image. For a list of the MCM settings and to which monitors they correspond, refer to Appendix D.

Using this print, you can determine the image that best matches the image as viewed at a diagnostic monitor, and use the corresponding MCM setting for print jobs.

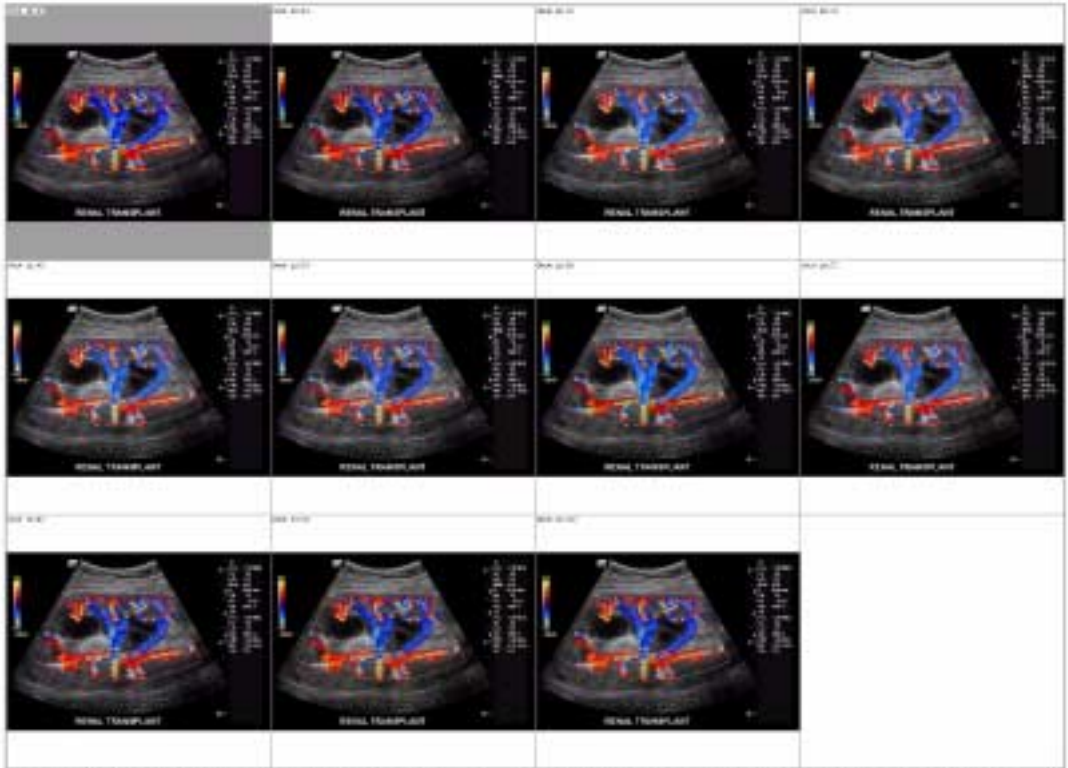

BRACKETING: MCM Gamma: 1.0 Contrast: 0 Saturation: 0

MCM Bracketing Sheet

Printing MCM Bracketing Sheets Using DICOM

To print MCM bracketing sheets from DICOM, configure the Image Display Format to **CUSTOM\8** from within your DICOM user application.

If you do not specify the media type and size for the bracketing sheet from within the DICOM user application, then the Horizon imager determines whether the image is grayscale or color. The imager then uses the Default Media defined for that type of image, and the Default User Settings defined for that media type and size. For more information about how to define the Default Media selection and Default User Settings, refer to “Changing the Default Media Type and Size” on page 8-3 and “Changing Default User Settings for a Media Type” on page 8-5.

Once a bracketing sheet is printed, you can use it to determine which MCM setting you want to use.

Printing MCM Bracketing Sheets Using PostScript

To print MCM bracketing sheets via PostScript, set the Sheet Layout parameter to **MCM Bracket**, and specify the media type/size using the Media Type and Media Size settings. For more information about changing parameter settings when printing via PostScript, refer to Chapter 6.

Once a bracketing sheet is printed, you can use it to determine which MCM setting you want to use.

10

Preventive Maintenance

Recommended Maintenance Schedule

The major cause of degraded imager performance and image output quality is dirt and dust. Perform the following preventive maintenance periodically.

Table 10-1. Recommended Maintenance Schedule

Maintenance	Schedule	Procedure on
Clean the thermal print head and nosepiece	<ul style="list-style-type: none">• Every 1000 sheets.• If you notice image quality problems.• If there is visible accumulation of debris.	page 10-3
Clean the platen and donor guide bar	<ul style="list-style-type: none">• Every 1000 sheets.• If you notice image quality problems.• If there is visible accumulation of debris.	page 10-8
Clean the pick tires	<ul style="list-style-type: none">• Every 1000 sheets, or more often in dirty conditions.• If the imager has trouble picking sheets from a cassette.	page 10-13
Clean the barcode reader window	Every 12 months.	page 10-15

Table 10-1. Recommended Maintenance Schedule (cont.)

Maintenance	Schedule	Procedure on
Clean the cassette area, sheet exit area, receive trays, basement, and imager cabinet with a platen roller wipe (refer to "Horizon Cleaning Kits" below)	Every 2000 sheets to eliminate dust buildup and prevent dirt from getting inside the imager.	page 10-18
Thermal print head calibration	Every 5000 sheets or 12 months, whichever comes first.	<i>Horizon Imager Technical Manual</i>
Film calibration	This calibration is done automatically whenever a new cassette is inserted for the first time. You can also run this calibration manually at any time (for example, if it has been more than three months since the cassette was calibrated).	page 11-2
Internal densitometer calibration	As needed. Typically, you will not need to perform this calibration. It uses an external instrument against which to calibrate the internal densitometer.	<i>Horizon Imager Technical Manual</i>

Horizon Cleaning Kits

The following cleaning kits are available to help you properly maintain the Horizon imager:

- The Horizon Platen and Print Head Cleaning Kit (catalog no. SP-00118) includes the special thermal print head and platen roller wipes that you will need to clean the thermal print head, platen, donor guide, and pick tires.
- The Horizon Barcode Reader Cleaning Kit (catalog no. SP-00130) includes the cotton swabs that you will need to clean the barcode reader window.

To order additional cleaning kits, contact Codonics at:

Phone: +1.440.243.1198
Toll Free: 800.444.1198 (USA only)
Fax: +1.440.243.1334
Web Site: www.codonics.com

Cleaning Print Head and Nosepiece



To clean the thermal print head and nosepiece

1. Press the **MENU** key.

The Main Menu displays.

2. Select the **Open Top Cover** menu option.

After selecting this option:

- The imager pauses, first completing the sheet if one is currently printing.
- If color ribbon is loaded, the ribbon supply spool inside the imager rises.
- After up to a minute to allow the thermal print head to cool, the imager cover pops partially open.
- The Open Top Cover menu displays.

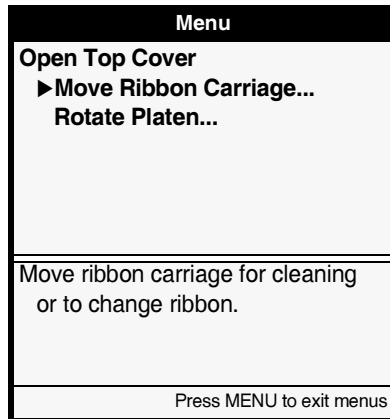

3. Open the top cover all the way.



WARNING With the imager cover open, touch only those internal components that are colored green (refer to the figure on page xxxii). Remove rings, ties, jewelry, and other items, and tie back hair, so that they do not fall into or get caught in the imager.

- If color ribbon is loaded, go to step 4. Otherwise, go to step 7.
4. Remove the ribbon, as shown in the following figure.

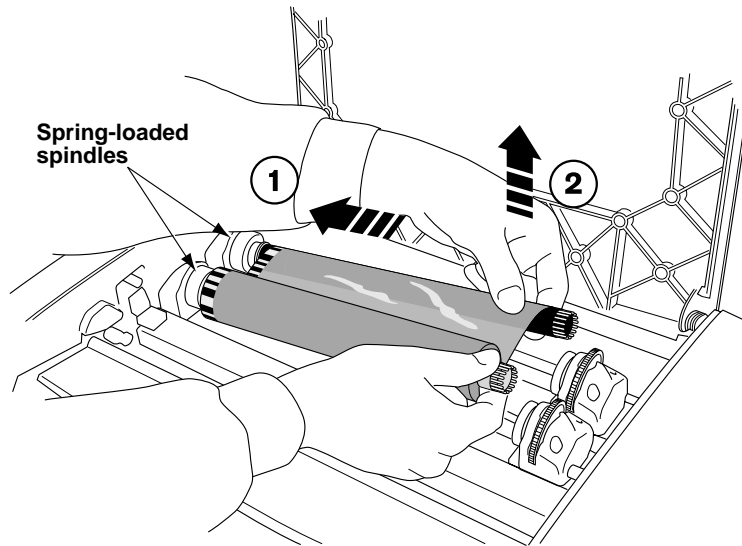

NOTE: Care should be taken with the ribbon to protect it from dust and dirt when it is not loaded in the imager. Avoid resting it on a table; static charge will attract dust from the table top.

5. From the Open Top Cover menu, select the **Move Ribbon Carriage** option.

The Move Ribbon Carriage menu displays.

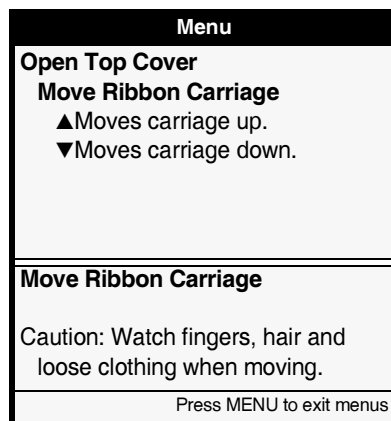

6. Press the  key to move the ribbon carriage down and out of the way.
7. Locate the print bead and nosepiece, shown in the following figure.

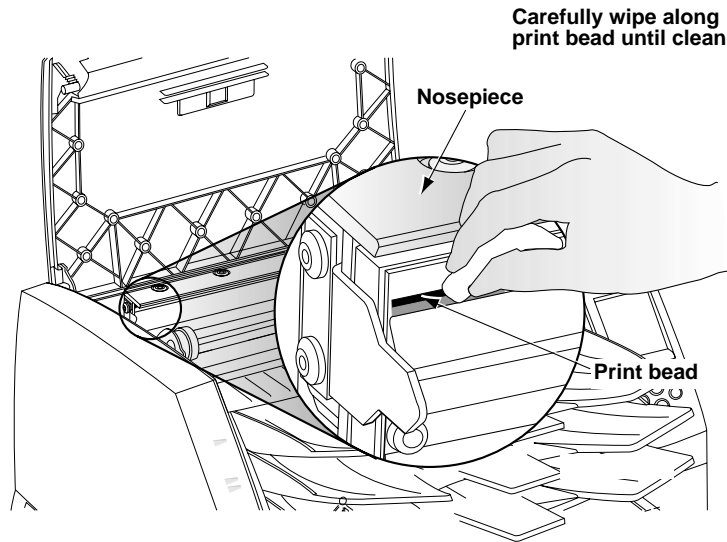

WARNING The thermal print head may be hot.

8. Using the print head cleaning wipe provided with the Platen and Print Head Cleaning kit, carefully wipe back and forth along the entire length of the print bead line with moderate pressure.
- Repeat the back and forth motion until the print bead is completely clean. Note that the cleaning pad may become discolored.



WARNING When cleaning the print head, avoid the extreme ends of the print head, which are sharp.



CAUTION Use only the print head cleaning wipe when cleaning the thermal print head. Also, do not touch the glass surface of the thermal print head with your fingers; it could damage the print head. To avoid touching the glass surface, you may want to wear gloves when cleaning the thermal print head.

9. Clean any dust or other contaminants from the nosepiece.
10. Wait for the thermal print head and nosepiece to dry thoroughly.
If you need to reload the color ribbon, go to step 11. Otherwise go to step 13.



CAUTION The thermal print head **must** be completely dry before attempting to use the imager. Allowing the thermal print head to heat up again while still wet will damage the thermal print head.



TIP: Cleaning the platen and donor guide bar while the top cover is open
If you want to clean the platen and donor guide bar while the imager is already open, refer to steps 7 through 12 in the procedure in “Cleaning the Platen and Donor Guide Bar” on page 10-8.

11. To reload the color ribbon, go to the Move Ribbon Carriage menu and press the  key to move the ribbon carriage up so you can reload the ribbon.

12. Reload the ribbon, as shown in the following figure.

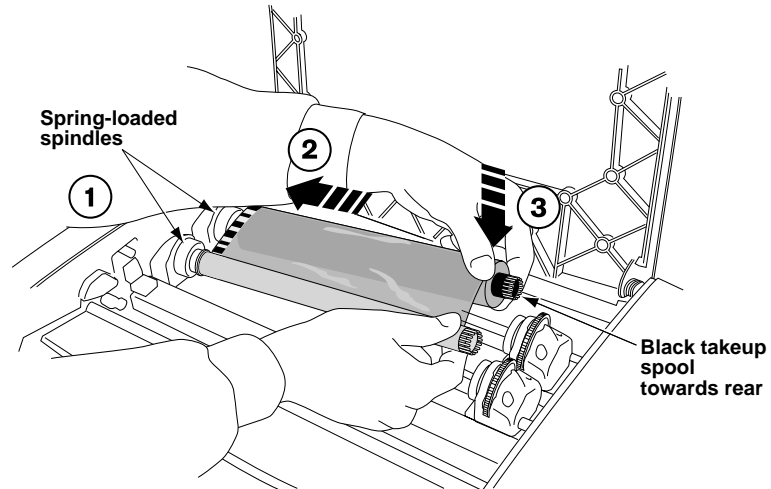

13. Close the top cover.

After a few seconds, the Status screen displays and printing resumes if jobs are queued.

Cleaning the Platen and Donor Guide



To clean the platen and donor guide bar

1. Press the **MENU** key.

The Main Menu displays.

2. Select the **Open Top Cover** menu option.

After selecting this option:

- The imager pauses, first completing the sheet if one is currently printing.
- If a color ribbon is loaded, the ribbon supply spool inside the imager rises.
- After up to a minute to allow the thermal print head to cool, the imager cover pops partially open.
- The Open Top Cover menu displays.

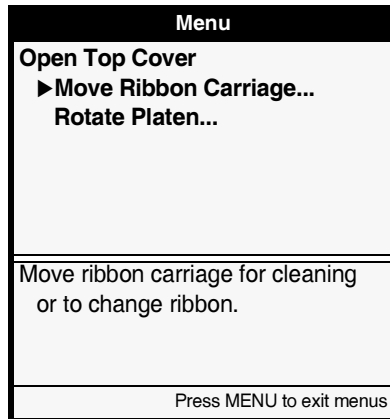

3. Open the top cover all the way.



WARNING With the imager cover open, touch only those internal components that are colored green (refer to the figure on page xxxii). Remove rings, ties, jewelry, and other items, and tie back hair, so that they do not fall into or get caught in the imager.

- If a color ribbon is loaded, go to step 4. Otherwise, go to step 7.
4. Remove the ribbon, as shown in the following figure.

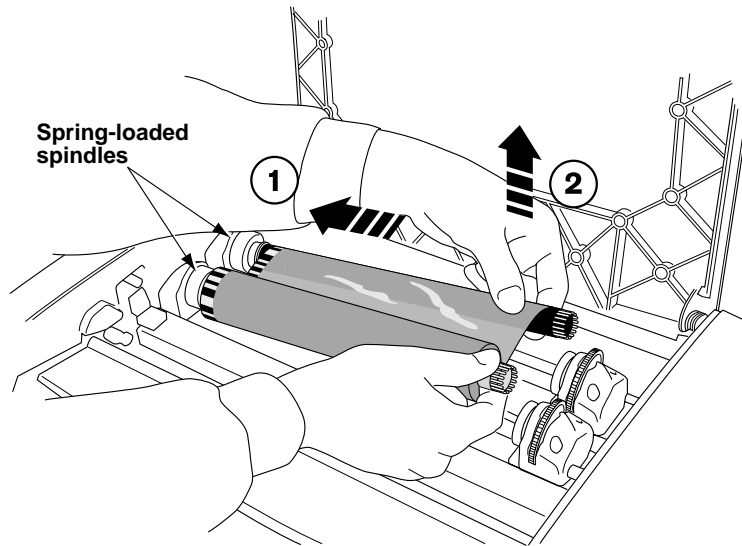

NOTE: Care should be taken with the ribbon to protect it from dust and dirt when it is not loaded in the imager. Avoid resting it on a table; static charge will attract dust from the table top.

5. From the Open Top Cover menu, select the **Move Ribbon Carriage** option.

The Move Ribbon Carriage menu displays.

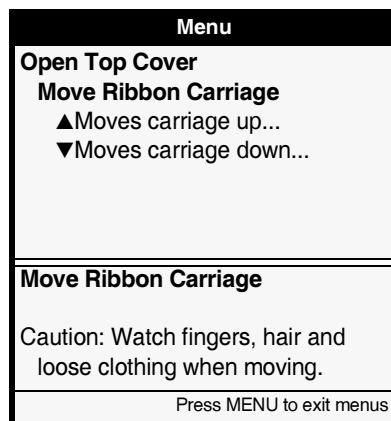

6. Press the **▼** key to move the ribbon carriage down and out of the way.
7. Looking in from the side of the imager, locate the orange or white platen roller and donor guide bar, shown in the following figure.

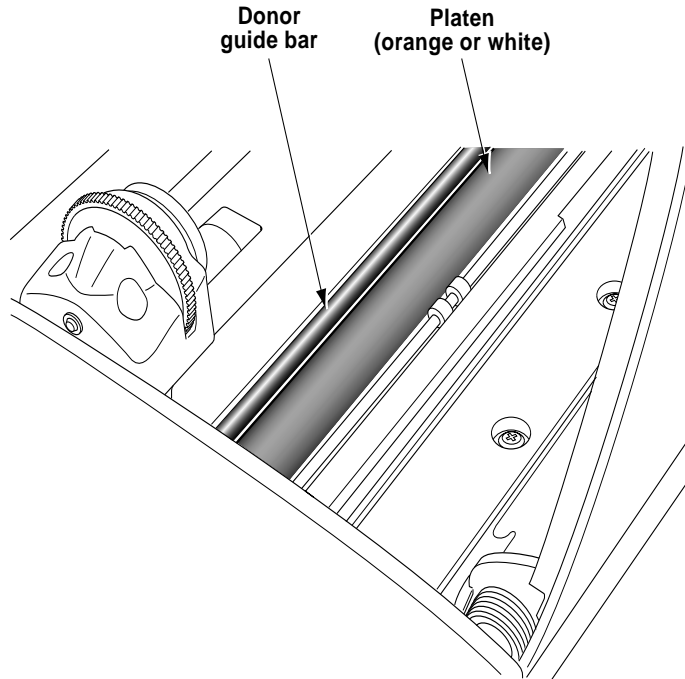

8. If the Move Ribbon Carriage menu is displayed, press the **◀** key to return to the Open Top Cover menu.
9. Clean any dust or other contaminants from the donor guide bar using the platen roller cleaning wipe provided with the Platen and Print Head Cleaning kit.

- From the Open Top Cover menu, select the **Rotate Platen** option.

The Rotate Platen menu is displayed.

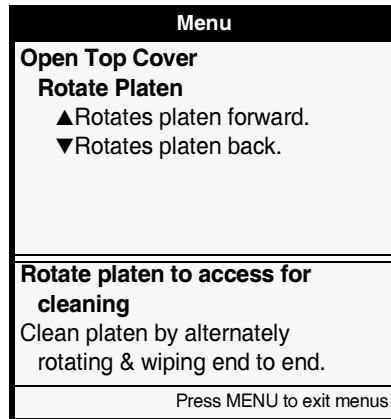

- Using the platen roller cleaning wipe, rub the pad along the entire length of the platen from end to end until all visible contaminants are gone. Do not rub back and forth.

Press the ▲ and ▼ keys to rotate the platen so that you can clean its entire surface.



CAUTION Use only the platen roller cleaning wipe when cleaning the platen. The platen roller could be damaged if you use the print head cleaning wipe.

- Wait for the platen and donor guide bar to dry thoroughly.

If you need to reload the color ribbon, go to step 13. Otherwise go to step 15.



TIP: Cleaning the thermal print head and nosepiece while the top cover is open
If you want to clean the thermal print head and nosepiece while the top cover is already open, refer to steps 7 through 10 in the procedure in "Cleaning Print Head and Nosepiece" on page 10-3.

- To reload the color ribbon, go to the Move Ribbon Carriage menu and press the ▲ key to move the ribbon carriage up so you can reload the ribbon.

14. Reload the ribbon, as shown in the following figure.

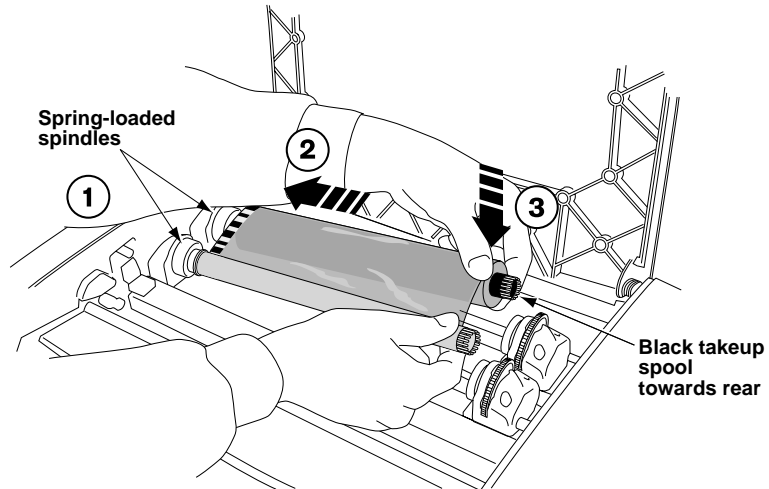

15. Close the top cover.

After a few seconds, the Status screen displays and printing resumes if jobs are queued.

Cleaning the Pick Tires



To clean the pick tires

1. Press the **PAUSE** key, and wait until the imager enters the Paused state.

The Status screen should indicate that the imager is paused.

2. Remove the receive trays, as shown in the following figure.

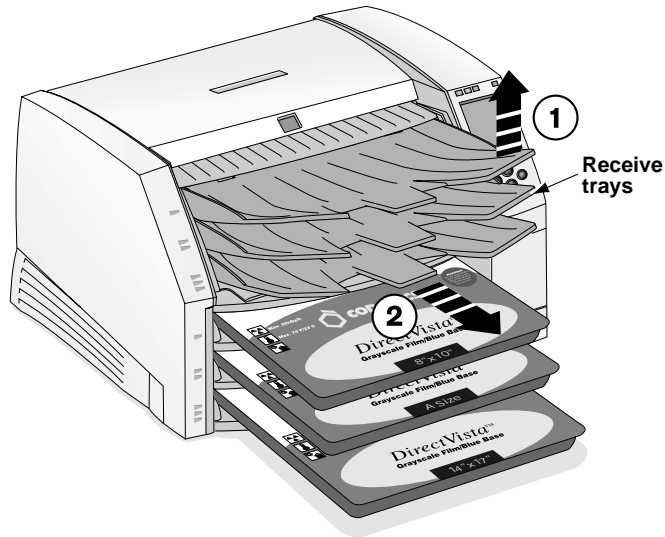

WARNING With the receive trays removed, touch only those internal components that are colored green (refer to the figure on page xxxii). Remove rings, ties, jewelry, and other items, and tie back hair, so that they do not fall into or get caught in the imager.

3. Place the receive trays on a flat surface, as shown in the following figure.

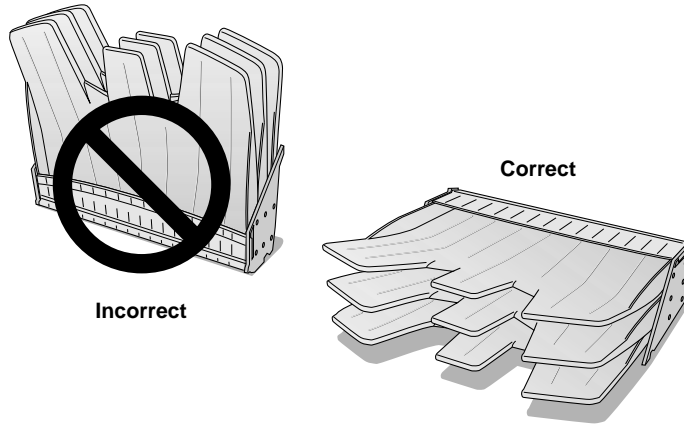

4. Remove any cassettes from the supply slots.
5. Locate the pick tires.

There are three pickers, one for each supply slot. The topmost picker is shown in the following figure.

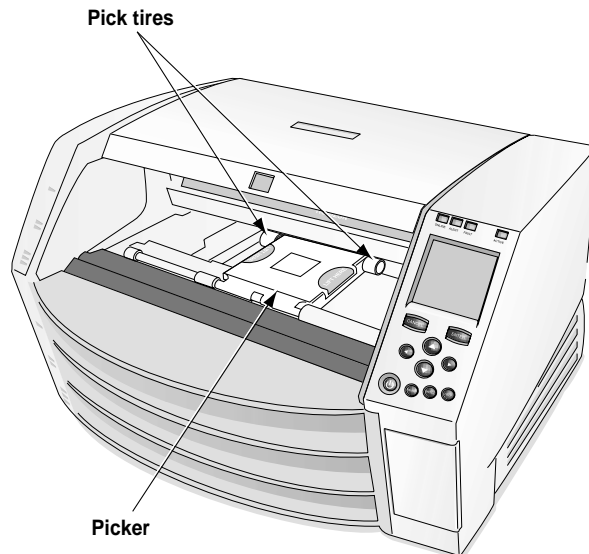

- Wipe around each tire with the platen roller cleaning wipe that is provided with the Platen and Print Head Cleaning kit.

Note that the cleaning wipe may become discolored.



CAUTION Use only the platen roller cleaning wipe when cleaning the pick tires. The tires could be damaged if you use the print head cleaning wipe.



CAUTION Do not touch the pick tires (which may be white or green); body oils from your fingers are hard to remove and could eventually damage the tires.

- Wait for the pick tires to dry thoroughly.
- Replace the receive trays and any media cassettes that were removed.

After a few seconds, the Status screen displays and printing resumes if jobs are queued.

Cleaning the Barcode Reader Window



To clean the
barcode
reader window

- Press the **PAUSE** key, and wait until the imager enters the Paused state.

The Status screen should indicate that the imager is paused.

- Remove any cassette currently in supply slot 1, and make sure that the receive trays are in and the top cover is closed.

- Press the **MENU** key.

The Main Menu displays.

- Select the following options:

Utilities
Clean Barcode Reader

Instructions for cleaning the barcode reader are displayed.

5. Follow the instructions at the control panel.

- At some point in the instructions, you will be prompted to remove the receive trays.

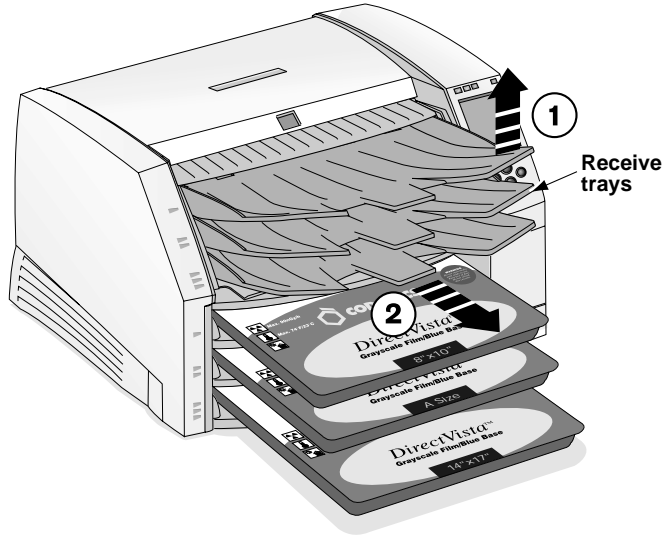

WARNING With the receive trays removed, touch only those internal components that are colored green (refer to the figure on page xxxii). Remove rings, ties, jewelry, and other items, and tie back hair, so that they do not fall into or get caught in the imager.

- When you remove the receive trays, place them on a flat surface, as shown in the following figure.

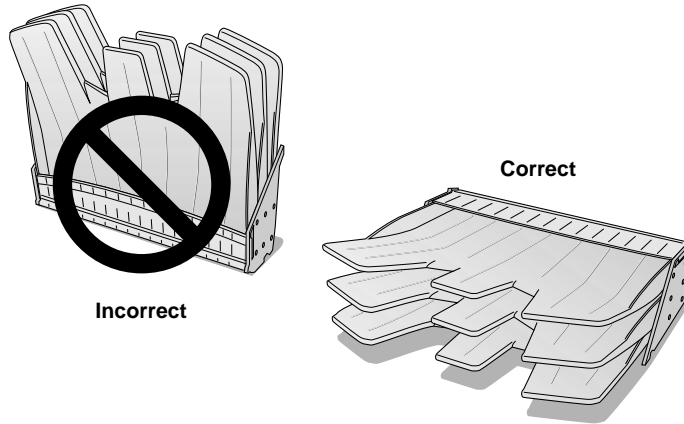

- Refer to the following figure to help you locate the barcode.

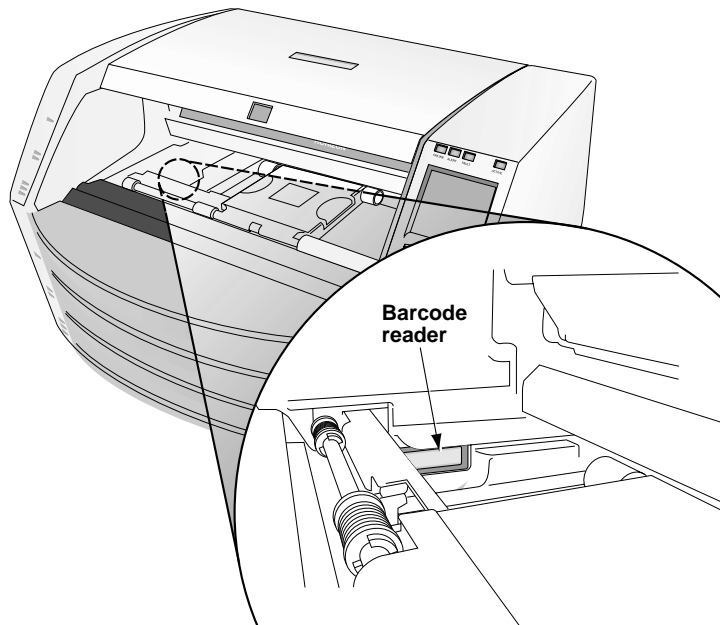

- When prompted to clean the barcode reader, use one of the cleaning swabs provided with the Barcode Reader Cleaning Kit and rub across the barcode reader window until all dust and other contaminants are removed.



CAUTION Use only cleaning swabs from a Barcode Reader Cleaning Kit.

- At some point in the instructions, you will be prompted to replace the receive trays and any supply cassettes.

When you have completed the cleaning instructions, the Status screen displays and printing resumes if jobs are queued.

General Cleaning Procedures

It is important to periodically clean components on the Horizon imager to keep them free of dust and debris.

Cleaning the Area Around the Imager

Clean the area around and under the imager to keep dust out of the cooling fans.

Cleaning the Receive Trays

Remove the receive trays. Using a platen roller wipe (refer to “Horizon Cleaning Kits” on page 10-2), clean the receive trays of any dust or debris. Use compressed air to blow inside the sheet metal at the inside bottom of the receive trays—referred to as the *hide track*—to remove any dust, then wipe the trays. (When printing a **ChromaVista** sheet, the imager advances the unfinished sheet into the hide track for all but the final color pass).

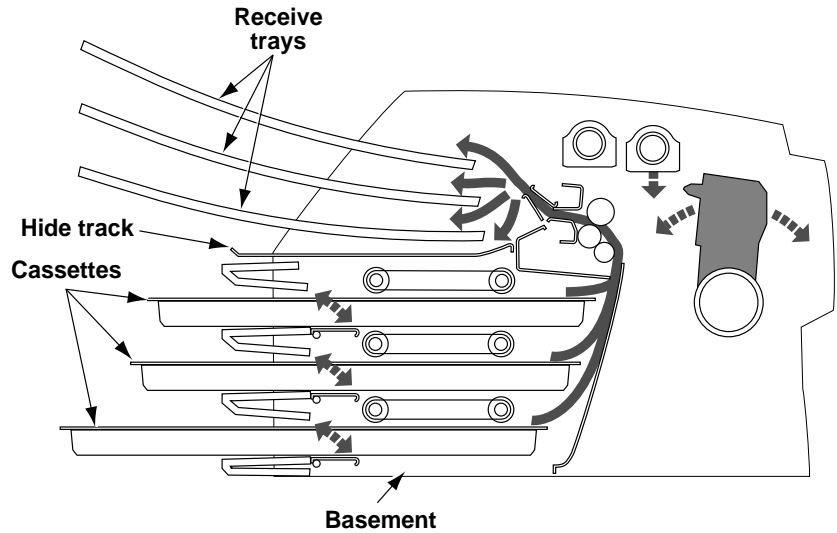

Cross-Section of Imager, Showing Location of Hide Track and Basement

Cleaning the Basement

The *basement* is the polished sheet metal at the bottom, inside of the imager (see the figure on page 10-19). When printing a **ChromaVista** sheet, the imager backs up the unfinished sheet into the basement for all but the final color pass.

Using a platen roller wipe (refer to “Horizon Cleaning Kits” on page 10-2), gently clean the basement of any dust or debris.



CAUTION Do not scratch or nick the sheet metal. Scratches and nicks in the basement will damage the printed side of **ChromaVista** sheets.

11

Calibration

There are several calibrations that are performed automatically, or can be performed manually, to optimize the image quality on printed sheets given variations in media and operating conditions:

- **Film calibration** is performed automatically by the imager when a **DirectVista** grayscale film cassette is inserted into the imager for the first time. You can also perform this calibration manually.
- **Internal densitometer calibration** allows you to recalibrate the imager's internal densitometer, which is used to read optical densities when a **DirectVista** grayscale film calibration is performed.
- **Thermal print head calibration** creates a characterization of the thermal print head to compensate for non-uniformities in the imaging properties of the print head.
- **Print length calibration** can be performed to correct for images running off or printing short of the bottom of a sheet.

Only the film calibration procedure is covered in this manual. For more information about the other calibrations, and some of the other automatic compensations made by the imager, refer to the *Horizon Imager Technical Manual*.

Film Calibration (**DirectVista Film Only**)

Film calibration is the process of characterizing a given combination of imager and **DirectVista** grayscale film to allow the imager to compensate for imager-to-imager variation and supply cassette-to-cassette variation.

When a **DirectVista** grayscale film cassette is loaded into the imager for the first time, the imager will print a test sheet and read that test sheet with the built-in densitometer, then recalibrate based on the results.

You can also perform a film calibration manually.



To perform a
film
calibration

1. Press the  key.

The Main Menu displays.

2. Select the following menu options:

Utilities
Film Calibrate

The Film Calibration menu displays, allowing you to choose the supply slot (referred to as Cassette 1, 2, or 3) in which the **DirectVista** grayscale film cassette is loaded.

3. Select the appropriate supply slot, then press the  key.

The imager prints a test sheet, recalibrating that cassette based on the result.



NOTE: If the selected supply slot does not have a **DirectVista** grayscale film cassette loaded, the calibration will not run.

12

Troubleshooting

Sources of Status Information

Control Panel

The control panel display shows the imager's operating status. The control panel also has **ALERT** and **FAULT** indicators, which light when the imager needs attention or an error occurs.

For additional information on how to interpret control panel status messages and indicators, refer to "Troubleshooting Tables" on page 12-2.

Error Log

The imager logs error messages to a log file. You can view the 100 most recent messages using the Error Log function. To view logged error messages, refer to "Viewing Logged Error Messages" on page 12-28.

Online Help for Displayed Messages

You can display help text for any of the messages displayed in the Status window. Simply move the selector arrow to the message for which you want further explanation, then press the  key.

Printing an Imager Status Test Print

You can print an Imager Status test print to verify general imager operation and to document the current configuration. For more information, refer to “Printing the Imager Status Test Print” on page 2-18.

Troubleshooting Tables

Table 12-1. Startup and Print Job Troubleshooting



Problem	Possible Causes	Solutions
Shipping damage.	Imager damaged by shipping company, incorrect packing.	Contact technical support (refer to “Contacting Technical Support” on page 12-30).
Imager does not power up when pressing the  (power) key at the control panel.	Imager is not turned on.	Push the power rocker switch at the back of the imager to the 1 (on) position, then retry pressing the  key at the control panel (refer to “Powering On the Imager—First Time” on page 2-10).
	Power cord is not properly connected.	Reset power cord on back of imager.
	Internal fuse or power supply is bad.	The internal power supply contains an integrated fuse which is not user serviceable. Contact technical support (refer to “Contacting Technical Support” on page 12-30).
	No power at the outlet.	Try plugging another device into the outlet to check whether there is any power. If there isn’t power to the outlet, then check to see why.

Table 12-1. Startup and Print Job Troubleshooting (cont.)





Problem	Possible Causes	Solutions
Control panel display shows an error during startup sequence.	Hardware component failed to initialize, component failure.	Cycle power to the imager by pushing the power rocker switch at the back of the imager to the 0 (off) position, waiting 10 seconds, then pushing the power switch back to the 1 (on) position (refer to “Powering On the Imager—First Time” on page 2-10). Then, press the  key at the control panel. If this does not clear the condition, contact technical support (refer to “Contacting Technical Support” on page 12-30), making a note of the error message.
Imager does not respond to pressing any control panel keys.	Imager is starting up or shutting down.	Wait for the imager to finish starting up, or wait for shutdown to complete (shutdown could take up to 10 minutes).
	Imager software has crashed.	<p>Press and hold down the  key at the control panel to force a shutdown. Wait for the imager to power down, then press the  key again to restart the imager.</p> <p>If this does not clear the condition, then cycle power to the imager by pushing the power rocker switch at the back of the imager to the 0 (off) position, waiting 10 seconds, then pushing the power switch back to the 1 (on) position (refer to “Powering On the Imager—First Time” on page 2-10). Then, press the  key at the control panel.</p> <p>If this still does not clear the condition, contact technical support (refer to “Contacting Technical Support” on page 12-30).</p>

Table 12-1. Startup and Print Job Troubleshooting (cont.)

Problem	Possible Causes	Solutions
Print jobs have been sent but the ACTIVE light never flashes.	Internal problem with imager or with network connection.	<p>Check that network cable is properly connected.</p> <p>Check that the Horizon imager's network settings are correct.</p> <p>Check that the Horizon imager's IP address is set correctly at the host sending the print job.</p>
	Print job sent to another imager.	Check that the imaging device is configured properly.
	Problem with the sending device.	Check that the sending device's print queue is not stopped or in an error state.
	Trying to use an unsupported feature (for example, unsupported media, or the source—DICOM or PostScript—is not supported on your imager).	Check that you are using only features that were purchased for and enabled on the imager.
	A temporary feature key has expired.	Check the error log using the Error Log function in the Utilities menu to see whether a required feature (such as DICOM) is not enabled. Contact your Codonics representative to purchase a permanent feature key for that feature.
Images transfer but no sheet is printed.	Correct media not loaded.	Look for message at the control panel indicating which media type must be loaded. Load that requested media type.
	A temporary feature key has expired.	Check the error log using the Error Log function in the Utilities menu to see whether a required feature (such as DICOM) is not enabled. Contact your Codonics representative to purchase a permanent feature key for that feature.
	Trying to use an unsupported feature (for example, unsupported media, or the source—DICOM or PostScript—is not supported on your imager).	Check that you are using only features that were purchased for and enabled on the imager.

Table 12-1. Startup and Print Job Troubleshooting (cont.)

Problem	Possible Causes	Solutions
Image transfers but the image's cell on the printed sheet is empty. Instead, the cell contains the message "image processing failed."	Unknown or corrupt image file format.	Make sure images being sent to the imager are one of the supported formats (refer to the specifications in Appendix B). Make sure the sending application is not sending corrupt or incomplete images.
Imager settings are unexpectedly changed.	The control panel menus were accessed and parameters were changed unintentionally.	Check to see if the imager's default settings are what you expect. If not, change them. You can restore the imager default settings from backup media (refer to "Restoring the Configuration Settings from Backup Media" on page 2-24).
Sheet and/or image settings on printed sheets do not reflect what is set through the control panel.	Settings entered through the DICOM application interface or the Job Settings file associated with the selected Horizon imager Called AE Title are overriding the imager's User Default Settings.	To use the User Default Settings specified at the control panel, select a Horizon imager Called AE Title that does not specify any Job Settings parameters (for example, Print_SCP). Also, do not specify any custom settings through the DICOM application interface or PostScript printer settings. All settings will then defer to the imager's User Default Settings.
Status screen indicates "Head cooling, please wait ..." for extended period of time (greater than one minute), or this message displays often.	Improper ventilation.	Allow at least 10 cm (4 in.) at back and sides of imager. Move imager to a cooler location.

Table 12-2. Sheet Jam Troubleshooting

Problem	Possible Causes	Solutions
Sheet jams or misfeeds.	Cassette is not seated properly.	Slide the cassette out, then back into the slot to make sure it is seated properly.
	The imager is being operated in an area of high or low humidity that is outside of the specified range for the imager. This can cause the media to curl.	Check the media for curling or other distortion. If there is distortion, replace the media. Try to control temperature and humidity in the area where the imager is located, or move the imager to a more suitable location.
	Sheet is still jammed in the imager.	If a sheet is still jammed in the imager, remove it (refer to “Clearing a Sheet Jam” on page 12-14).
	Very dirty pick tires or platen.	Clean the platen (refer to “Cleaning the Platen and Donor Guide Bar” on page 10-8) and the pick tires (refer to “Cleaning the Pick Tires” on page 10-13).
	Sheets are blocked or stuck together due to heat, humidity, or improper storage.	Wearing rubber gloves, carefully fan the media. To help prevent sheets from sticking together, store cassettes upright (the way they come packed in their shipping boxes), not lying flat.
	Receive tray is full.	Remove sheets from the receive tray.
Imager is double-picking sheets.	Sheets are blocked or stuck together due to heat, humidity, or improper storage.	Wearing rubber gloves, carefully fan the media.
		To help prevent sheets from sticking together, store cassettes upright (the way they come packed in their shipping boxes), not lying flat.

Table 12-3. Image Quality Troubleshooting

Problem	Possible Causes	Solutions
Scratches (that is, physical abrasions) on the sheet.	There is a substantial buildup of dirt on the thermal print head, or a burr or abrasion on a component in the media path.	<p>Clean the thermal print head (refer to “Cleaning Print Head and Nosepiece” on page 10-3).</p> <p>Perform general cleaning procedures (refer to “General Cleaning Procedures” on page 10-18).</p> <p>If cleaning does not correct the problem, contact technical support (refer to “Contacting Technical Support” on page 12-30).</p>
<p>Dust spots (single light spots) on the sheet.</p> <p>These are white on DirectVista grayscale media and multicolored on ChromaVista color media.</p>	Dust on the sheet.	<p>Clean the thermal print head (refer to “Cleaning Print Head and Nosepiece” on page 10-3) and platen (refer to “Cleaning the Platen and Donor Guide Bar” on page 10-8).</p> <p>Perform general cleaning procedures (refer to “General Cleaning Procedures” on page 10-18).</p>
<p>Dust comet (single light spot with a tail) on the sheet.</p> <p>These are white on DirectVista grayscale media and multicolored on ChromaVista color media.</p>	Dust on the sheet.	<p>Clean the thermal print head (refer to “Cleaning Print Head and Nosepiece” on page 10-3) and platen (refer to “Cleaning the Platen and Donor Guide Bar” on page 10-8).</p> <p>Perform general cleaning procedures (refer to “General Cleaning Procedures” on page 10-18).</p>
Dust streak (a blurry streak) on the sheet.	Dust was dragged down the length of the sheet.	<p>Clean the thermal print head (refer to “Cleaning Print Head and Nosepiece” on page 10-3) and platen (refer to “Cleaning the Platen and Donor Guide Bar” on page 10-8).</p> <p>Perform general cleaning procedures (refer to “General Cleaning Procedures” on page 10-18).</p>
Dark or light soft-edged vertical streak on all sheets.	Contamination on thermal print head.	Clean the thermal print head (refer to “Cleaning Print Head and Nosepiece” on page 10-3).

Table 12-3. Image Quality Troubleshooting (cont.)

Problem	Possible Causes	Solutions
Clear, hard-edged vertical white streak on all sheets.	Blown element on the thermal print head or bad cable.	Need new thermal print head or cable. Contact technical support (refer to “Contacting Technical Support” on page 12-30).
Vertical streaking across the entire sheet.	Thermal print head needs to be calibrated.	Calibrate the thermal print head (refer to “Cleaning Print Head and Nosepiece” on page 10-3). If calibration does not fix the streaking, the problem could be software related; contact technical support (refer to “Contacting Technical Support” on page 12-30).
Dark spot that repeats every few inches on the sheet.	Dust on the platen.	Clean the platen (refer to “Cleaning the Platen and Donor Guide Bar” on page 10-8).
Faint horizontal line across the sheet.	Imager was jarred while printing. Receive trays causing interference with media transport.	Avoid jarring the imager when it is printing (for example, when changing cassettes). Consider moving the imager to minimize accidental jarring. Make a test print with the receive trays removed. Contact technical support for assistance (refer to “Contacting Technical Support” on page 12-30).
Bright, multi-colored horizontal streaks on colored sheet.	The ribbon may be wrinkled on the spool, or the ribbon is damaged.	Install a new ribbon [refer to “Changing the Ribbon (ChromaVista)” on page 4-8] and make another print.
Image did not print; error message printed at location where image should have been.	Image sent for printing is invalid, in an unsupported format, or corrupt.	Make sure that the image is in a format supported by the imager (refer to the specifications in Appendix B), and that it is not corrupt.

Table 12-3. Image Quality Troubleshooting (cont.)

Problem	Possible Causes	Solutions
The message “Warning: Image Decimated” is printed in the corner of an image.	The Image Warnings option has been enabled, and the image has been decimated. Decimation occurs if pixels are removed from an image so that it can fit in its cell area on the sheet.	<p><i>If image decimation is acceptable</i> and you do not want the message to print, disable the Decimation warning (refer to Appendix D) and reprint the image.</p> <p><i>If image decimation is not acceptable</i>, specify a smaller size for the image at the image source device or pick a format that allows for a larger image area on the sheet.</p>

Table 12-4. Media Cassette and Ribbon Troubleshooting

Problem	Possible Causes	Solutions
Printed sheets are falling from the imager.	Receive tray is full.	Remove the sheets from the receive tray.
The imager cannot read the cassette barcode.	If the cassette is valid, the barcode label may not be correctly positioned or the barcode reader window may be dirty.	Try reinserting the cassette. If this does not work, check the barcode label position and/or clean the barcode reader window (refer to “Cleaning the Barcode Reader Window” on page 10-15). If none of this works, manually enter the barcode number (refer to “Manually Entering a Cassette Barcode” on page 12-26).
The imager indicates that the barcode is invalid.	There is a problem with the cassette’s barcode.	Contact your Codonics representative.
The imager indicates that the media is contaminated or that the sheet count has been exceeded.	Additional sheets were inserted into the supply cassette beyond what was originally packaged.	For quality control reasons, you cannot add sheets to a supply cassette.

Table 12-4. Media Cassette and Ribbon Troubleshooting (cont.)

Problem	Possible Causes	Solutions
The imager indicates that media needs to be loaded.	A print job was received that requires a media type/size that is not currently loaded.	Load the appropriate cassette. If you do not have the required cassette, you can let all other jobs print, then purge the print queue to remove that job (refer to “Purging Print Jobs” on page 12-25).
	The cassette is loaded but not seated properly.	Reseat the cassette.
You insert a cassette, but the imager does not recognize that one is present.	If the imager does not respond to having the cassette inserted in any of the slots, the software may not be operating properly.	Reboot the imager.
	If only one slot is not working, that slot’s cassette sensor may have failed.	Move the cassette to a different slot. Then contact technical support (refer to “Contacting Technical Support” on page 12-30).
	Cassette sensors are dirty.	Clean the cassette sensors. Contact technical support for details.
The imager indicates that a media supply cassette is not supported.	The imager does not support that media type/size option.	Either do not use that media size/type, or contact your Codonics representative to purchase that media option.
The imager indicates that the receive trays must be inserted.	The receive trays are not installed, or are not seated properly.	Properly install the receive trays.
The imager indicates that the ribbon needs to be replaced.	The ribbon has run out.	Replace the ribbon [refer to “Changing the Ribbon (ChromaVista)” on page 4-8].
The control panel indicates that no ribbon is loaded, when a ribbon is loaded.	Ribbon is inserted upside down or backwards.	Insert the ribbon properly [refer to “Changing the Ribbon (ChromaVista)” on page 4-8].
	The ribbon currently loaded is not a Codonics ribbon.	You must use Codonics ribbon.
	Failed ribbon sensor.	Contact technical support (refer to “Contacting Technical Support” on page 12-30).

Table 12-4. Media Cassette and Ribbon Troubleshooting (cont.)

Problem	Possible Causes	Solutions
Film calibration failed.	Film too light or too dark.	Try using another cassette, or move the cassette to another slot.
	There is a problem with the film (the film emulsion side is facing the wrong way).	Make sure that the film emulsion side is facing the right way.
	A jam prevented the film from moving, but the imager thought it was reading it.	Check for and correct any sheet jams.
	Film itself bad.	Try using another cassette.
	There is a problem with the densitometer (for example, dust is in the way).	Clean the imager. Refer to “General Cleaning Procedures” on page 10-18.
	There is a problem with the imager. For example, two films were picked at once, or the imager is outside its operating range (for example, the internal temperature is too high).	Wearing rubber gloves, carefully fan the media. To help prevent sheets from sticking together, store cassettes upright (the way they come packed in their shipping boxes), not lying flat. Make sure that the imager fan is working, and that the room is within the proper temperature and humidity operating ranges (refer to Appendix B for operating specifications).

Table 12-5. Miscellaneous Troubleshooting

Problem	Possible Causes	Solutions
Control panel displays “Invalid smart card.”	Smart Card is not firmly seated.	Remove and insert the Smart Card.
	Incorrect Smart Card is inserted from another model imager.	Reinsert the imager’s original Smart Card.
	Smart Card is damaged.	Contact technical support for a replacement (refer to “Contacting Technical Support” on page 12-30).

Table 12-5. Miscellaneous Troubleshooting (cont.)

Problem	Possible Causes	Solutions
Experiencing connection errors at console or workstation from which DICOM print jobs are sent	Running DICOM Lite on imager, and need more connections than is provided by DICOM Lite.	Contact technical support about upgrading to full DICOM (refer to “Contacting Technical Support” on page 12-30).

Status Message Tables

Common Cassette Status Messages

The following table lists the common cassette-related status messages.

Table 12-6. Cassette Status Messages

Message	Explanation
Barcode error	The supply cassette’s barcode cannot be read.
Calibrating	The imager is performing a calibration. When performing a film calibration (when a DirectVista grayscale film cassette is first inserted, or initiated manually through the Main Menu), the “calibrating” message toggles with supply information.
Calibration failed	For a film calibration, the calibration test film is either too light or too dark, indicating that there could be a problem with the film, imager, or densitometer. Also, dust or dirt could be blocking the densitometer and affecting valid readings.
Checking cassette	The imager is reading the supply cassette’s barcode, or waiting to read the barcode (for example, if the top cover is open, barcode will not be read).
Media contaminated	The media in loaded supply cassette does not match the information from the cassette’s barcode. For example, cassette has been loaded with additional unknown sheets.
Media Jam	A jam as occurred with media from the indicated cassette.







Table 12-6. Cassette Status Messages

Message	Explanation
<i>Media size, type, and count</i>	Indicates the type, size, and sheet count of the media cassette inserted in the corresponding supply slot. For example, 14x17 DV Blue 53 , indicating the cassette currently has 53 sheets of 14 x 17-in. DirectVista blue film.
No cassette	No cassette is loaded in the supply slot.
Printing	The imager is printing from the indicated cassette.
Unsupported media	The media in a loaded supply cassette is not supported by the imager (for example, ChromaVista color paper/white film is loaded but that media option was not purchased with the imager). Also could mean that the imager software is out of date (out-of-date software might not support a new media type, even if the new media type's feature key is enabled).

Color Ribbon Status

The following table lists the color ribbon status indications.

Table 12-7. Color Ribbon Status Indications

Indication	Explanation
	Blank; the imager supports only DirectVista grayscale media.
	Ribbon loaded. Ribbon type indicated (for example, CMY for cyan/magenta/yellow).
	Ribbon loaded but the ribbon is spent.
	Ribbon not loaded (and the imager does support ChromaVista color media).
	State of ribbon being determined.
	Ribbon loaded but in an error condition.

Clearing a Sheet Jam

A sheet may occasionally get jammed in the imager. If this happens:

- The imager goes offline.
- A fault message displays.
- The area at which the jam occurred is indicated in the Status window. (There may be intermediate messages, such as “Media jam occurred, please wait...,” while the imager is preparing for the jam to be cleared.)
- The **FAULT** indicator lights.
- An audible fault beep sounds until you clear the jammed sheet (or press any key).
- The imager pauses for up to a minute while the thermal print head cools, then partially pops open the top cover.

The message in the Status screen will be one of the following:

- **Clear jam from cassette X.** This message indicates that the sheet has jammed while being picked from the cassette and is:
 - Still in the cassette (the sheet never left the cassette, possibly because the pick tires are dirty and could not grab the sheet).
 - Stuck in the lower part of the imager (refer to the figure on page 12-15).
- **Clear jam from the printing area.** This message indicates that the sheet has jammed while printing and is:
 - Stuck in the lower part of the imager.
 - Stuck in the upper part of the imager. The upper part of the imager includes the thermal print head/platen area, the capstan/pinch roller area, the diverter, and the receive trays.

The following figure shows the media path within the imager, and indicates the lower and upper parts of the imager.

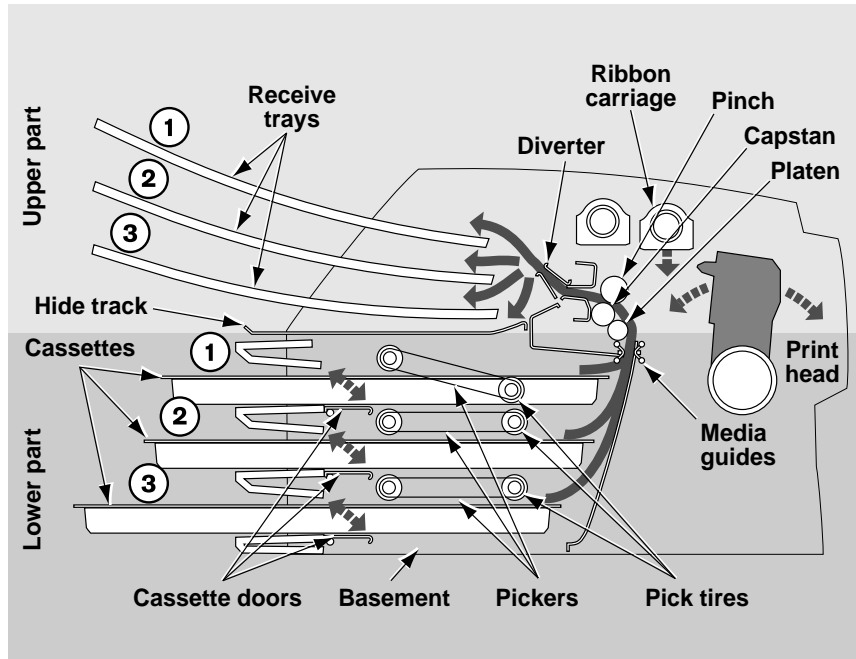

Troubleshooting

Cross-Section of Imager, Showing Internal Media Path

Clearing a jam from these likely locations is described in the following topics.

Clearing a Jam from a Cassette



NOTE: When a jam occurs, the imager disengages all motors to allow you to safely pull out the sheet.



To clear a jam indicated by “Clear jam from cassette X”

1. Gently pull out the supply cassette indicated in the message on the Status screen.
2. Check to see if the sheet is sticking out from the cassette or the supply slot.
 - *If the sheet is sticking out from the cassette or the supply slot, pull it out gently; then go to step 8.*
 - *If the sheet IS NOT sticking out from the cassette or the supply slot, go to the next step.*
3. Open the top cover (which has already been partially opened by the imager).



WARNING With the top cover open, touch only those internal components that are colored green (refer to the figure on page xxxii). Remove rings, ties, jewelry, and other items, and tie back hair, so that they do not fall into or get caught in the imager.

4. Remove the receive trays, as shown in the following figure.

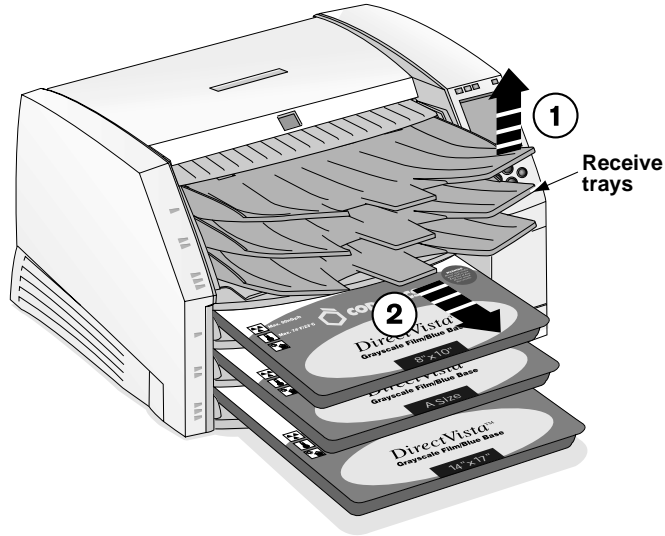

5. Place the receive trays on a flat surface, as shown in the following figure.

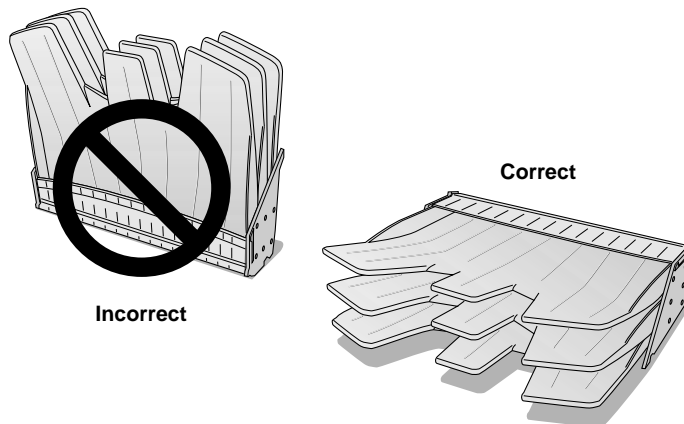

6. Remove all cassettes from the supply slots.

7. Look down in the imager to locate either the trailing or leading edge of the sheet:
 - *If you see the trailing edge in the lower part of the imager*, lift the pickers (refer to the figure on page 12-15) and gently remove the sheet, or push the corresponding cassette flap down and feed the sheet back out the supply slot opening.



CAUTION Do not touch the pick tires (which may be white or green); body oils from your fingers are hard to remove and could eventually damage the tires.

- *If you see the leading edge in the upper part of the imager*, gently pull the sheet out through the top of the imager.



CAUTION To avoid damaging internal components, use care when removing a sheet from the media path in the upper part of the imager.

8. Discard the sheet.



CAUTION Never put a sheet back in the cassette. Dust or oil from your finger will affect the image quality.

9. If the top cover is open, close it.

After a few seconds, the Status screen displays and printing resumes if jobs are queued.

Clearing a Jam from the Printing Area



NOTE: When a jam occurs, the imager disengages all motors to allow you to safely pull out the sheet.



To clear a jam indicated by “Clear jam from the printing area”



1. Open the top cover (which has already been partially opened by the imager).

WARNING With the top cover open, touch only those internal components that are colored green (refer to the figure on page xxxii). Remove rings, ties, jewelry, and other items, and tie back hair, so that they do not fall into or get caught in the imager.

2. Remove the receive trays, as shown in the following figure.

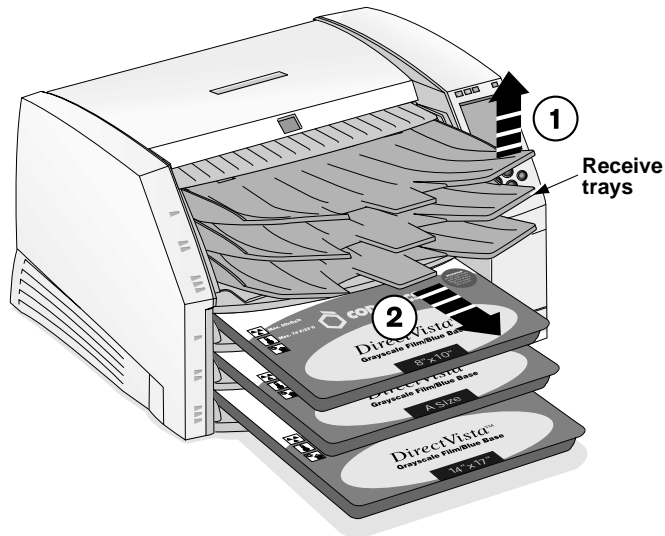

3. Place the receive trays on a flat surface, as shown in the following figure.

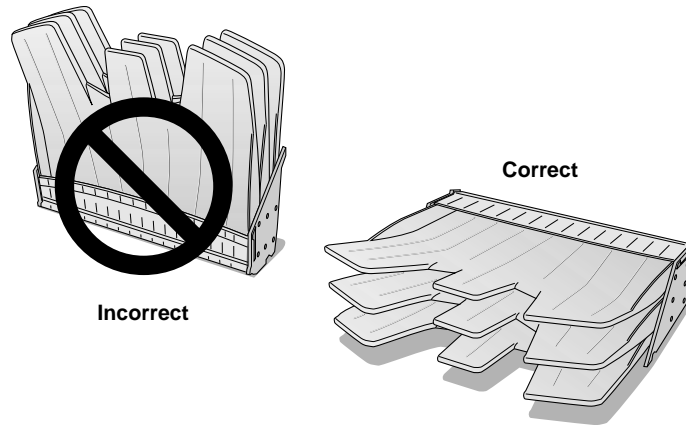

4. Remove all cassettes from the supply slots.
5. Check to see if the sheet is sticking out from one of the cassettes or supply slots.
 - *If the sheet is sticking out from one of the cassettes or supply slots, pull it out gently; then go to step 7.*
 - *If the sheet IS NOT sticking out from one of the cassettes or supply slots, go to the next step.*
6. Look down in the imager to locate either the trailing or leading edge of the sheet:
 - *If you see the trailing edge in the lower part of the imager, lift the pickers (refer to the figure on page 12-15) and gently remove the sheet, or push the corresponding cassette flap down and feed the sheet back out the supply slot opening.*



CAUTION Do not touch the pick tires (which may be white or green); body oils from your fingers are hard to remove and could eventually damage the tires.

- *If you see the leading edge in the upper part of the imager, gently pull the sheet out through the top of the imager.*



CAUTION To avoid damaging internal components, use care when removing a sheet from the media path in the upper part of the imager.



NOTE: To access the jammed sheet, you may need to remove the ribbon and/or move the ribbon carriage down using the **Load/Remove Ribbon** option in the Open Top Cover menu.

- *If the leading edge is through the diverter, gently pull the sheet out through the diverter (refer to the figure on page 12-15).*

7. Discard the sheet.



CAUTION Never put a sheet back in the cassette. Dust or oil from your finger will affect the image quality.

8. If the top cover is open, close it.

After a few seconds, the Status screen displays and printing resumes if jobs are queued.

Reinstalling Media Guides

When clearing sheet jams, the media guides could accidentally come out of their slots.

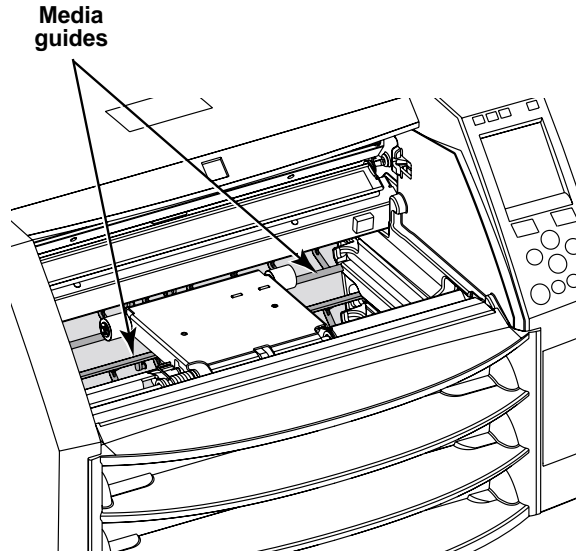

To reinstall the media guides

1. Slide the media guide into the imager through the cassette slots, as shown in the following figure.

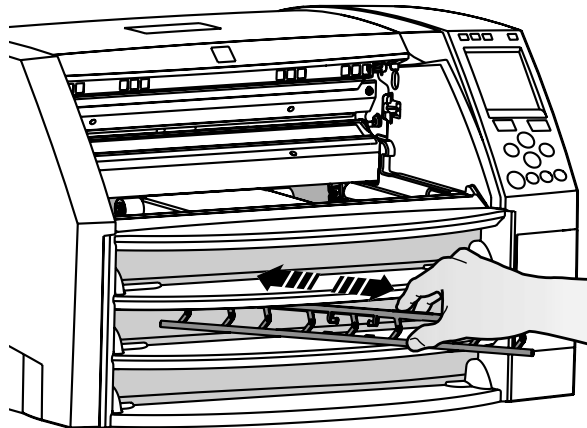

2. Insert the bottom leg of the media guide in both sides of the imager, as shown in the following figure.

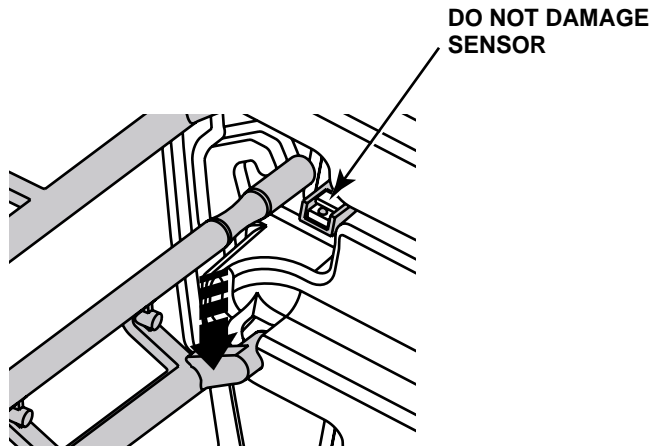

CAUTION Be careful not to scratch the polished sheet metal or damage the sensor near the upper guide notch.

3. Rotate the top leg into place, as shown below.

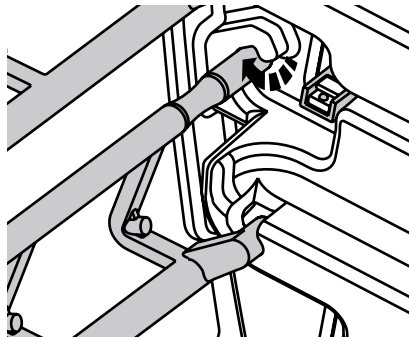



CAUTION Make sure you do not over-rotate the media guide, as shown below.



4. Repeat the procedure for the second media guide.

Purging Print Jobs

If necessary, you can purge all queued print jobs in the imager. For example, you may want to purge print jobs if you have a large print job that you decided not to print.



To purge all
queued print
jobs

1. Press the **MENU** key.

The Main Menu displays.

2. Select the following menu options:

Utilities

Purge Print Jobs

You are prompted to confirm the purge operation.

3. To continue with the purge, press the **ENTER** key.

All print jobs are purged, and the Utilities menu is displayed again.



CAUTION Use care when running the Purge Print Jobs function. This function will purge other users' print jobs as well as yours.

Manually Entering a Cassette Barcode

When a cassette is inserted into a supply slot, the Horizon imager reads the barcode to determine which media is loaded. If the imager cannot read the barcode, a barcode error message is displayed for that supply cassette entry in the Status screen.



If barcode information printed on the cassette is valid but the imager is just having trouble reading it, you can manually enter the barcode information from the control panel to correct the error.

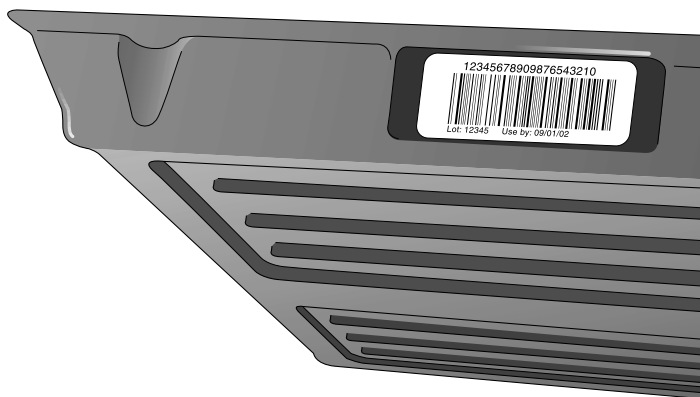

To override a
cassette
barcode

1. Locate the cassette's barcode number, on the left side of the cassette.



2. Record the cassette's barcode number, then insert the cassette into one of the supply slots.
3. At the imager's control panel, press and hold the  key, and while holding it press the  key.

The Main Menu with administrative options displays.

4. Select the following menu options:

Utilities
Enter Supply Barcode

The barcode information you entered is saved and you should now be able to use the cassette.

Viewing Logged Error Messages

You can view the most recent 100 messages entered into the error log.



To view the error log messages

1. Press the **MENU** key.

The Main Menu displays.

2. Select the following menu options:

Utilities
Error Log

The Error Log screen displays, listing the 100 most recent error messages.

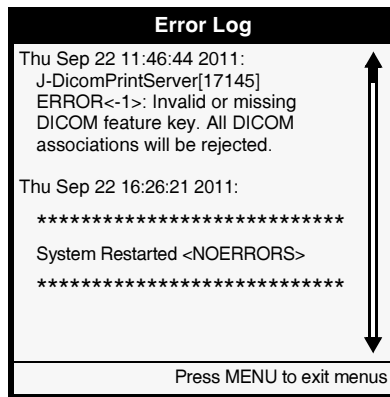

Viewing Imager Information Online

You can view imager information online.



To view
imager
information
online

1. Press the **MENU** key.
The Main Menu displays.
2. Select the following menu options:

Utilities
Imager Info

The Imager Info screen displays. You can use the **▼** key to scroll down to see the additional screens of information.

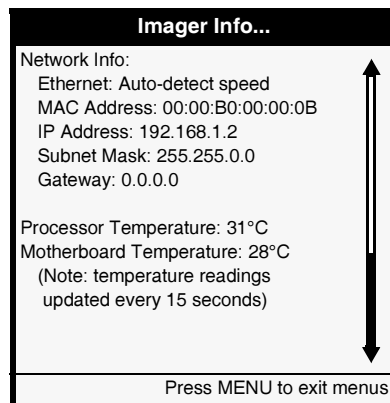
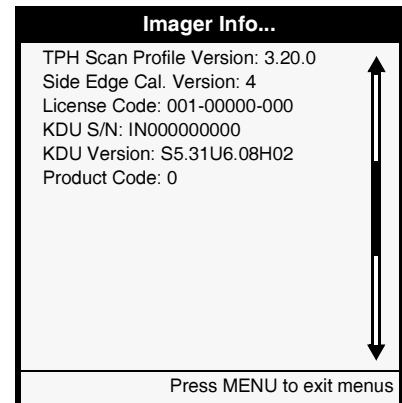
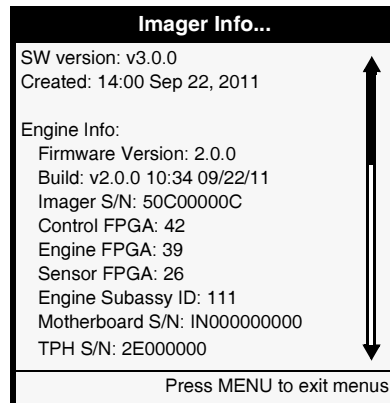

Contacting Technical Support

For questions regarding your Horizon Imager, please first refer to this manual, which describes the features and operations. This chapter includes troubleshooting tips for common problems.

If you cannot find the answer to your question in this manual, please visit the Codonics web site at www.codonics.com. The Technical Support area of the web site includes the latest product and troubleshooting information.

If your question was not addressed by the manual or the web site, technical assistance is available by phone at:

Phone: +1 440.243.1198
Toll Free: 800.444.1198 (USA only)

Technical support is available anytime.

If you do call for technical support, please have the following information on hand:

- The imager's serial number (on the back of the imager)
- The imager's license code (printed on the License Code Certificate which came with the imager, and on the imager's Smart Card)
- Any control panel status or error messages related to the problem



TIP: Other sources for serial number and license code

You can also find the serial number and license code in the Imager Info menu (refer to "Viewing Imager Information Online" on page 12-29) and on the Imager Status test print (refer to "Printing the Imager Status Test Print" on page 2-18).

Anonymous FTP

When trying to solve a support question, your technical support representative may ask you to upload files to the Codonics anonymous FTP site at

ftp.codonics.com

Valid logins for anonymous FTP are:

anonymous or **ftp**

For the password, enter your full email address.



CAUTION All files uploaded using anonymous FTP are readable by other FTP users. DO NOT upload sensitive or classified information.

File uploads should be placed in the **/incoming** directory. To avoid confusion on file uploads, please follow these guidelines:

- Check the **/incoming** directory before uploading your file to make sure a file with the same name as yours has not already been uploaded.
- All sample image print requests and problem report uploads should include an ASCII “readme” file that contains the following information:
 - Your company name
 - Your company’s full postal mailing address
 - Contact person
 - Phone number of contact person
 - Email of contact person
 - For problem reports, a description of problem
 - A list of the files being sent

Also, to save storage space, reduce upload time, and simplify file handling, images and readme files should be archived and compressed into one file:

- From Windows, use the PKZIP (*.zip) archive and compression format.
- From UNIX and Linux, use the **tar** command to archive the files into one file, then the **compress** command or an application such as **gzip** to compress the archive file.
- From a Macintosh, use the StuffIt archive and compression application.



If the images and readme files must be uploaded as separate files, choose a file naming scheme that is consistent. For example:

```
your_company1.tif  
your_company2.tif  
your_company.readme
```

A

Menu Hierarchy

This appendix includes the hierarchy of the menus displayed at the control panel.

Note that administrative options—which are displayed by pressing and holding the  key, and while holding it pressing the  key—are shown in gray type.

The Main Menu is shown below. Submenus are shown on subsequent pages.

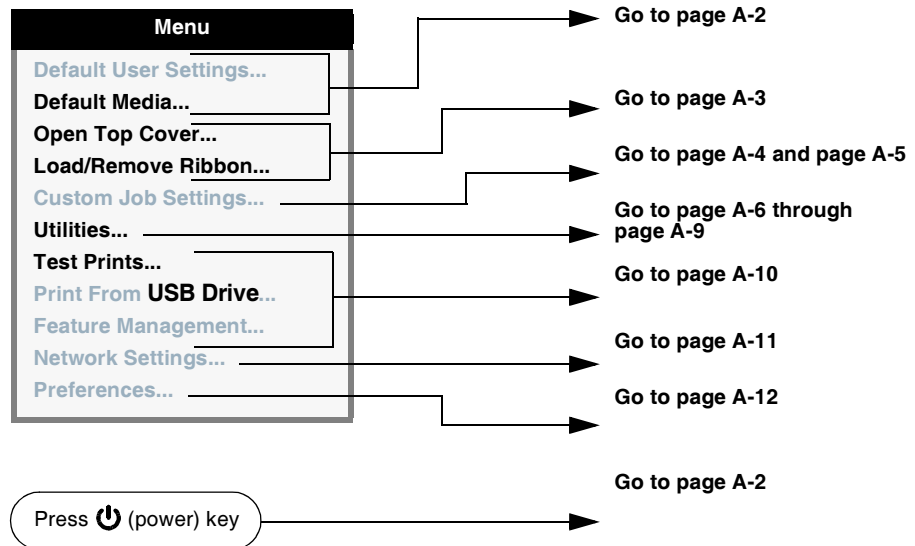

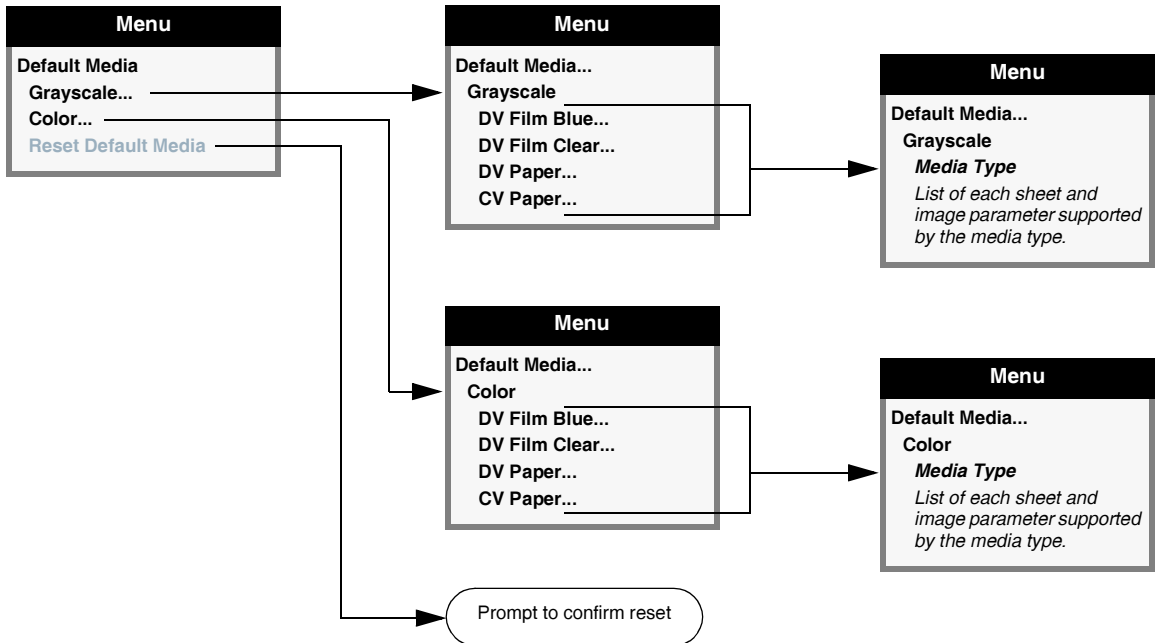
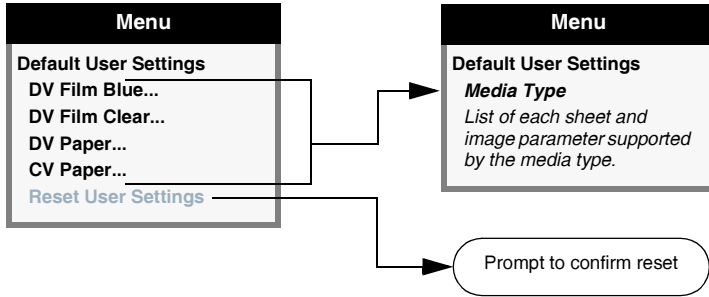
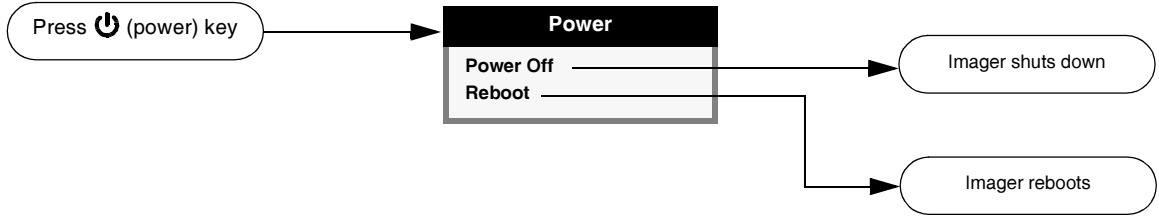

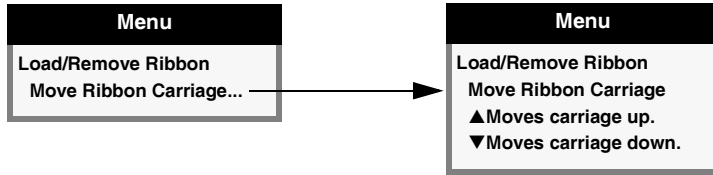
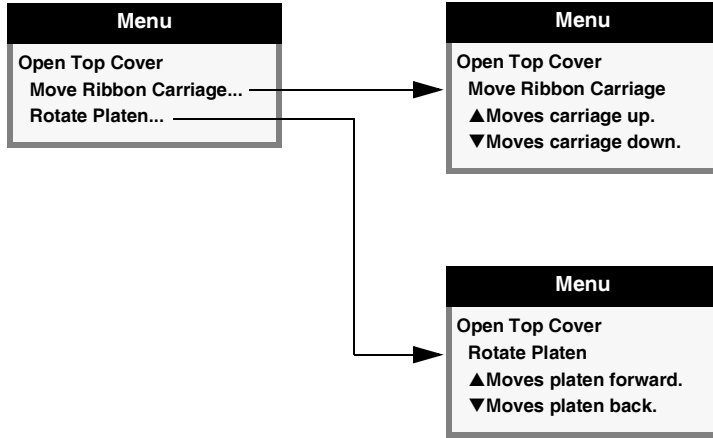

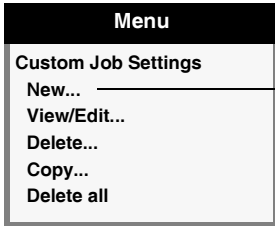

Submenus of other Custom Job Settings menu options are shown on the next page.

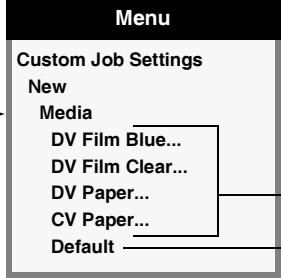
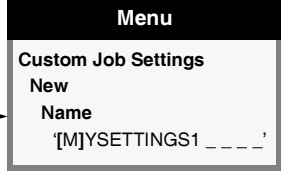
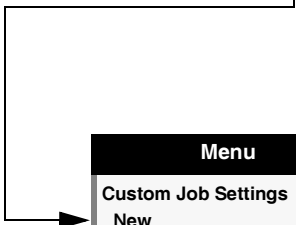

Specifies to use types selected in the Default Media menu.

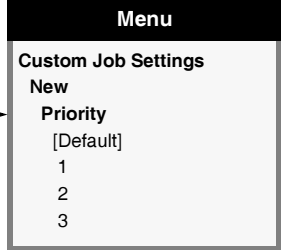
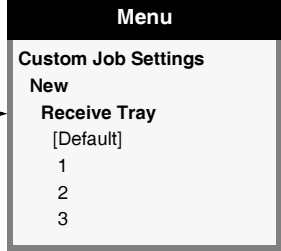

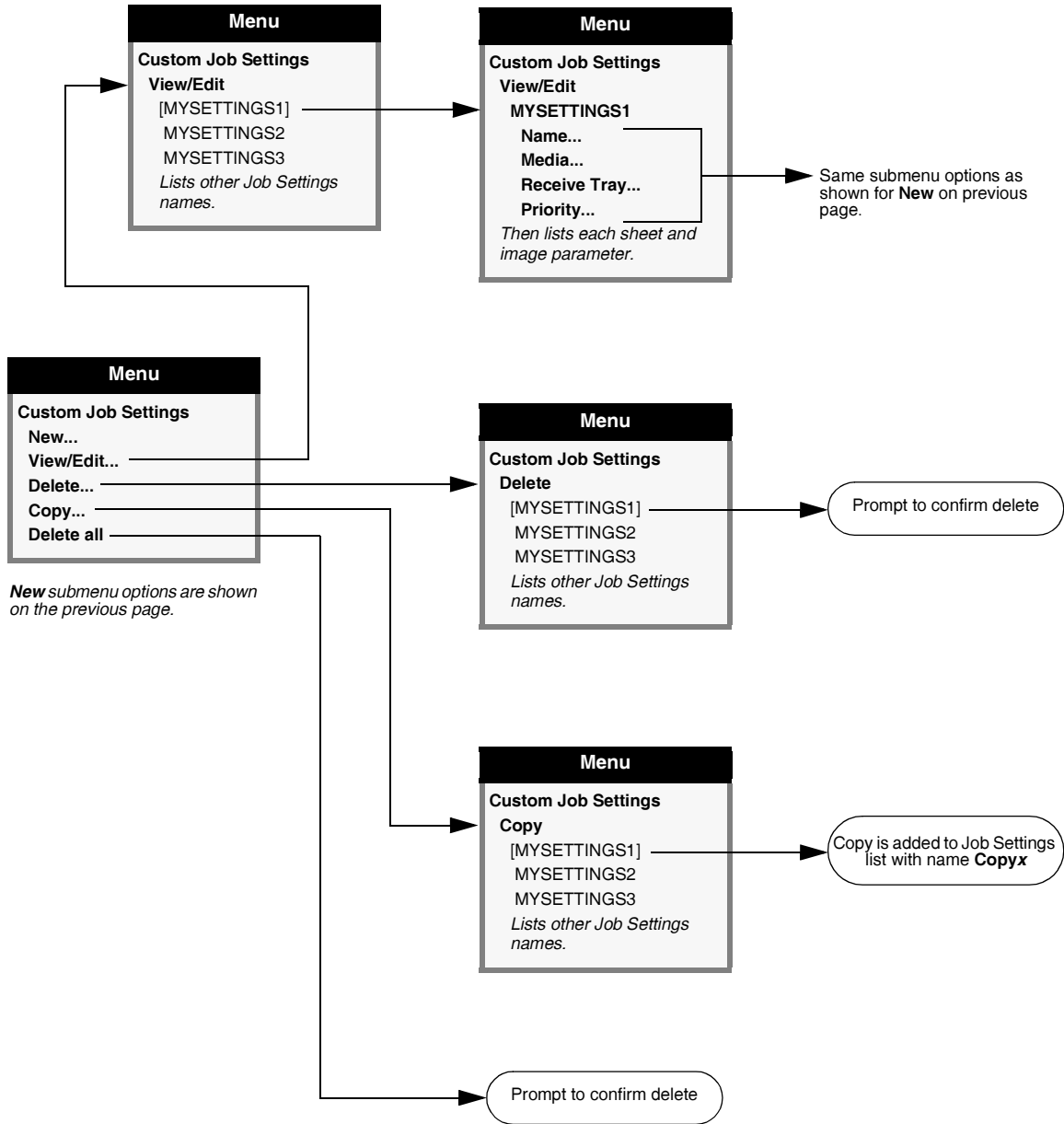

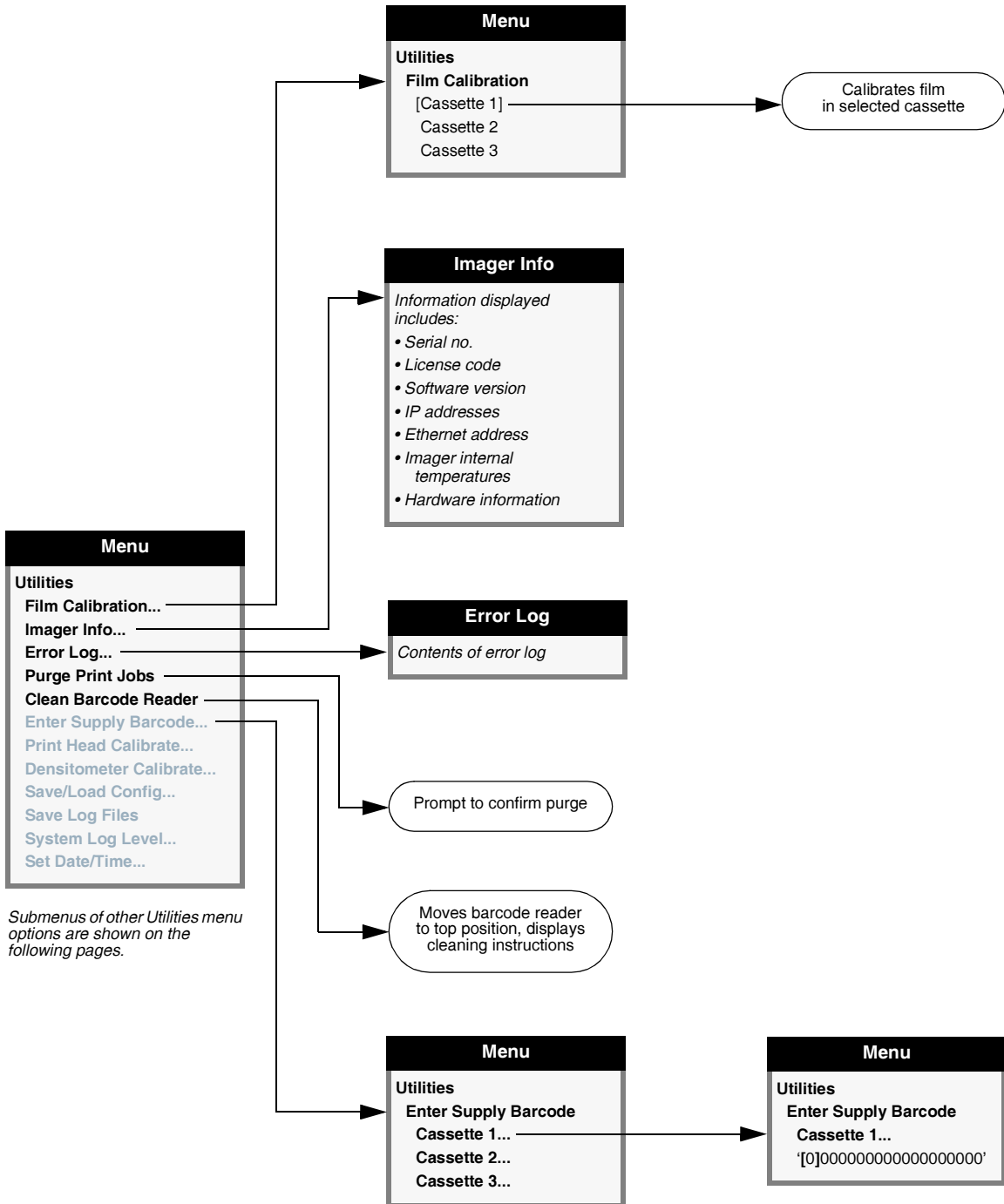

Submenus of other Utilities menu options are shown on the following pages.

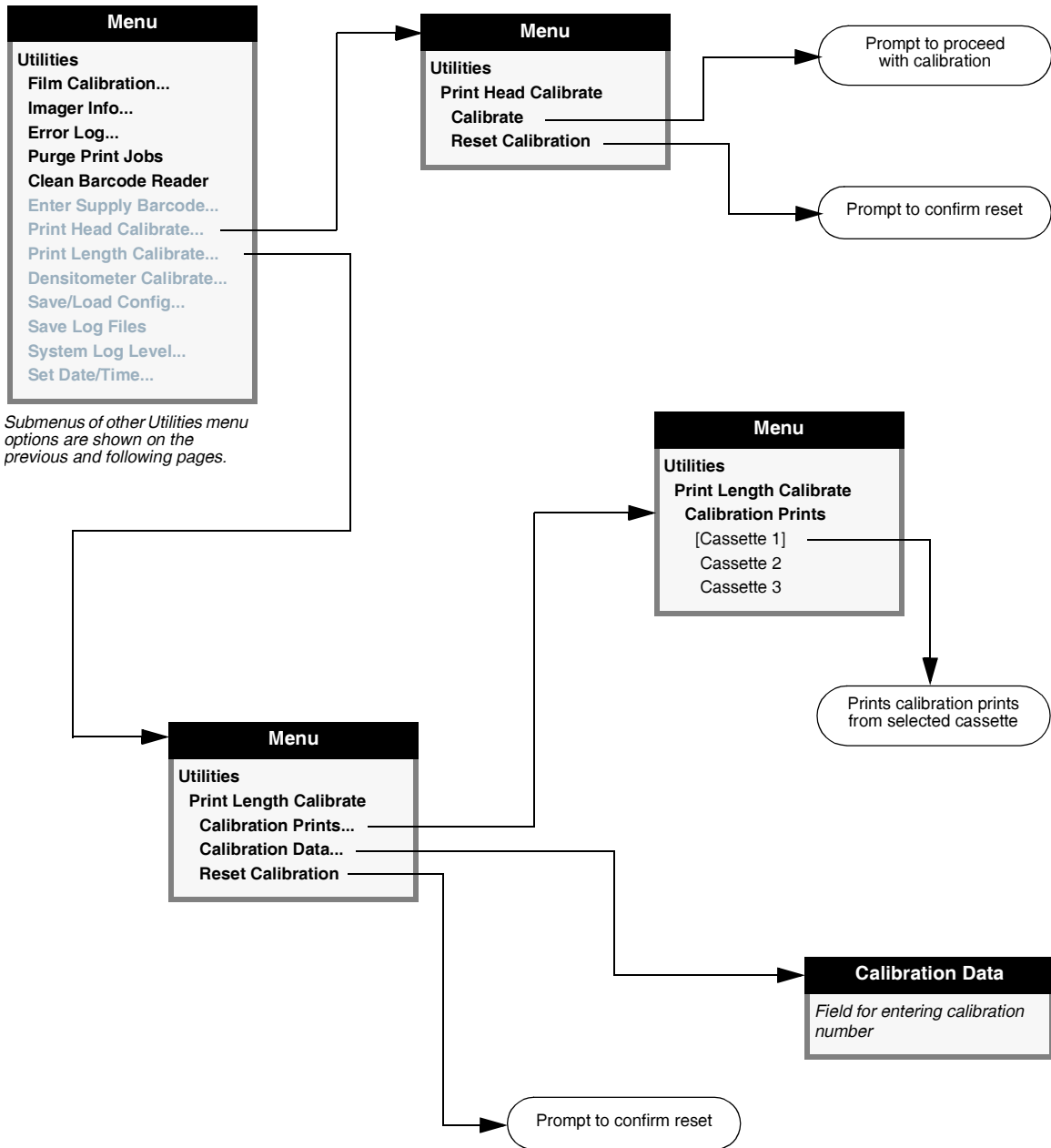

Menu Hierarchy

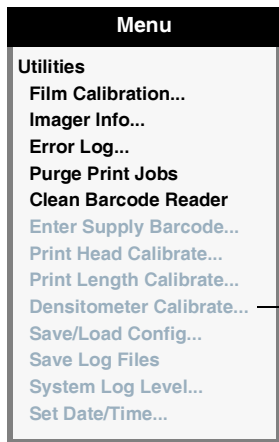

Submenus of other Utilities menu options are shown on the previous and following pages.

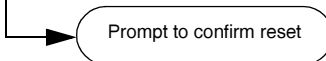
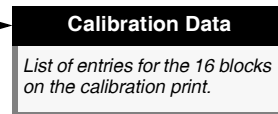
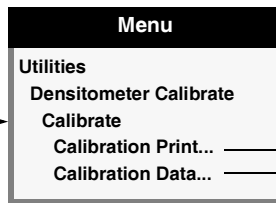
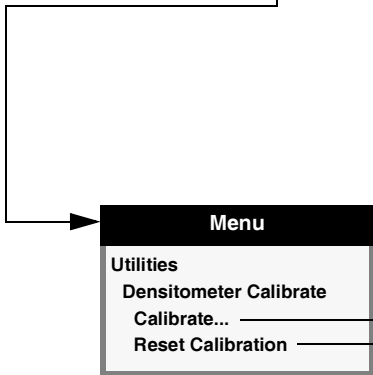
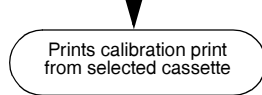
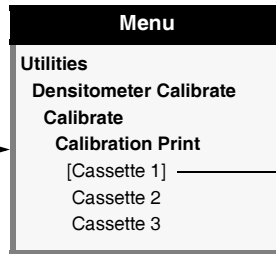

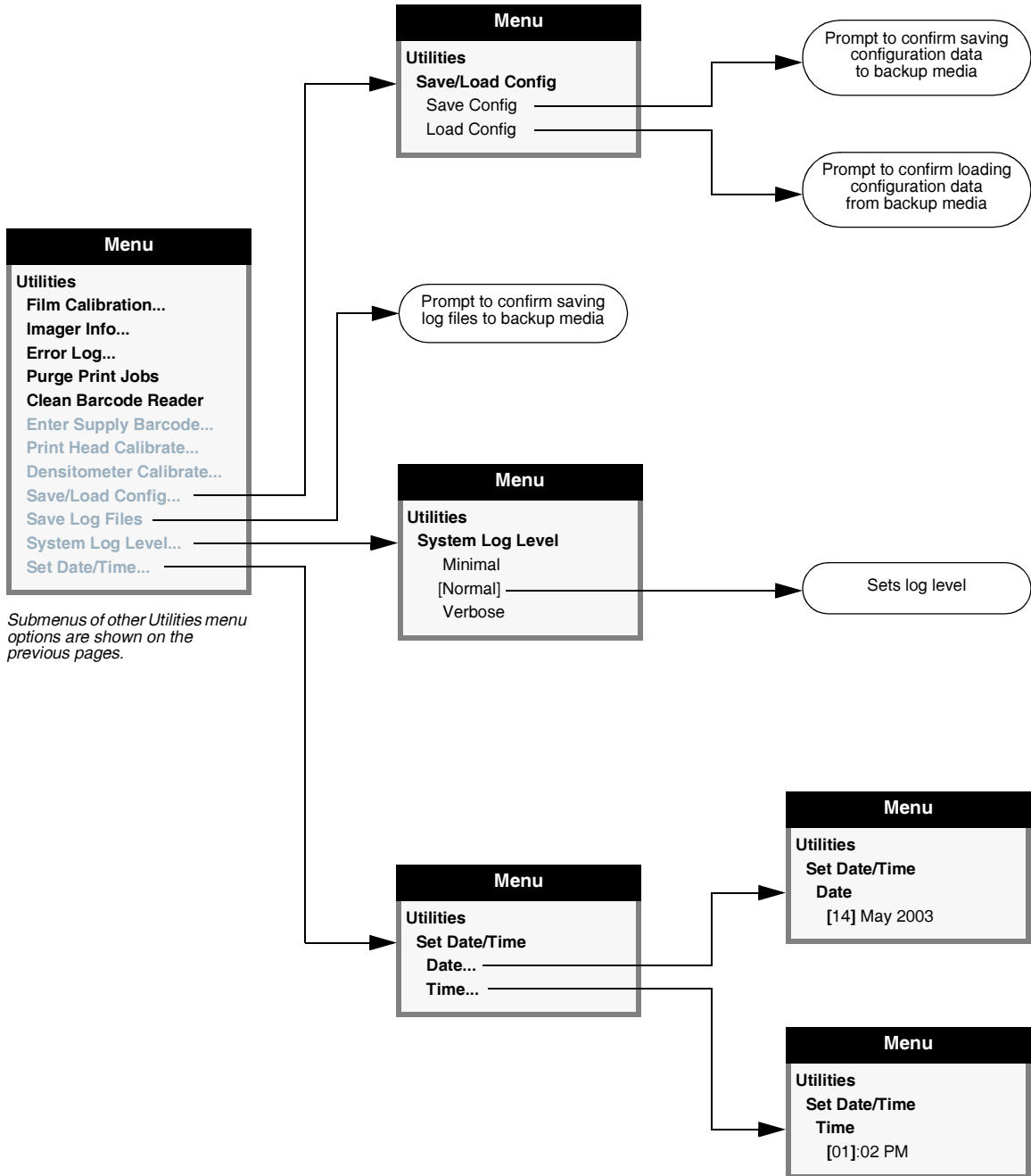

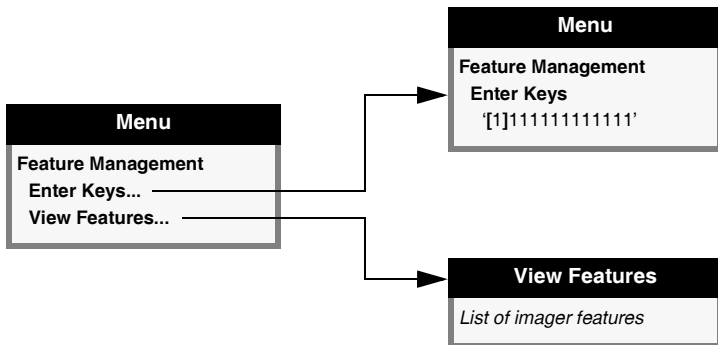
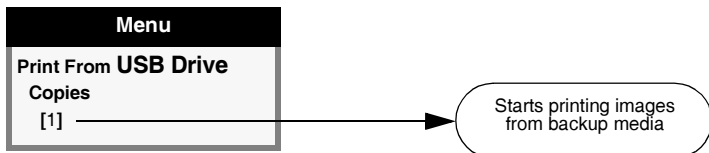
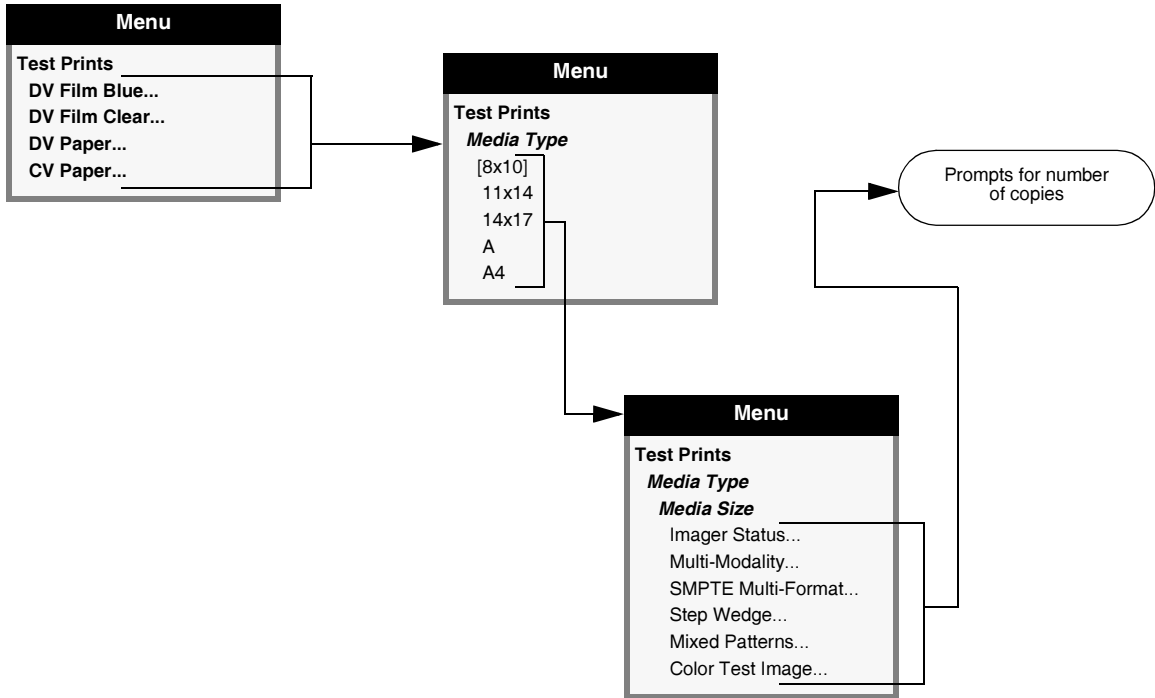

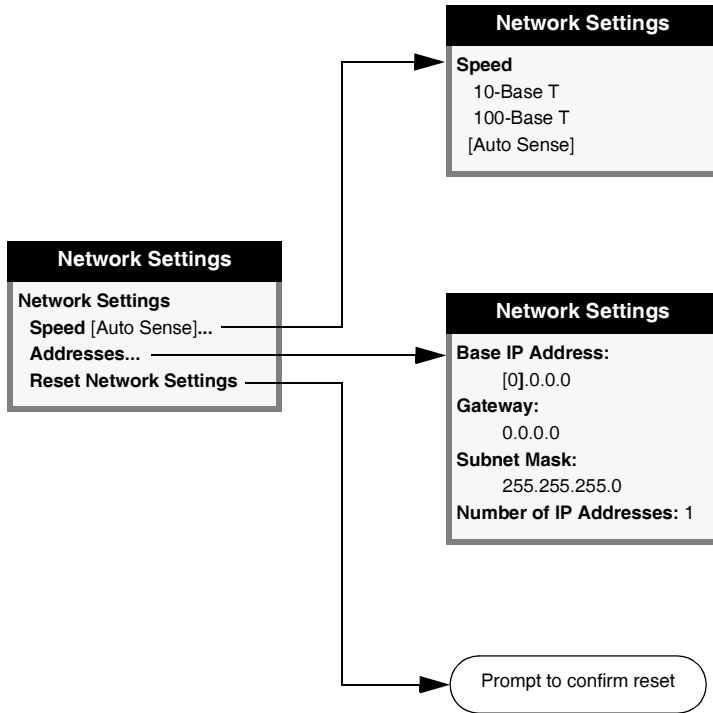

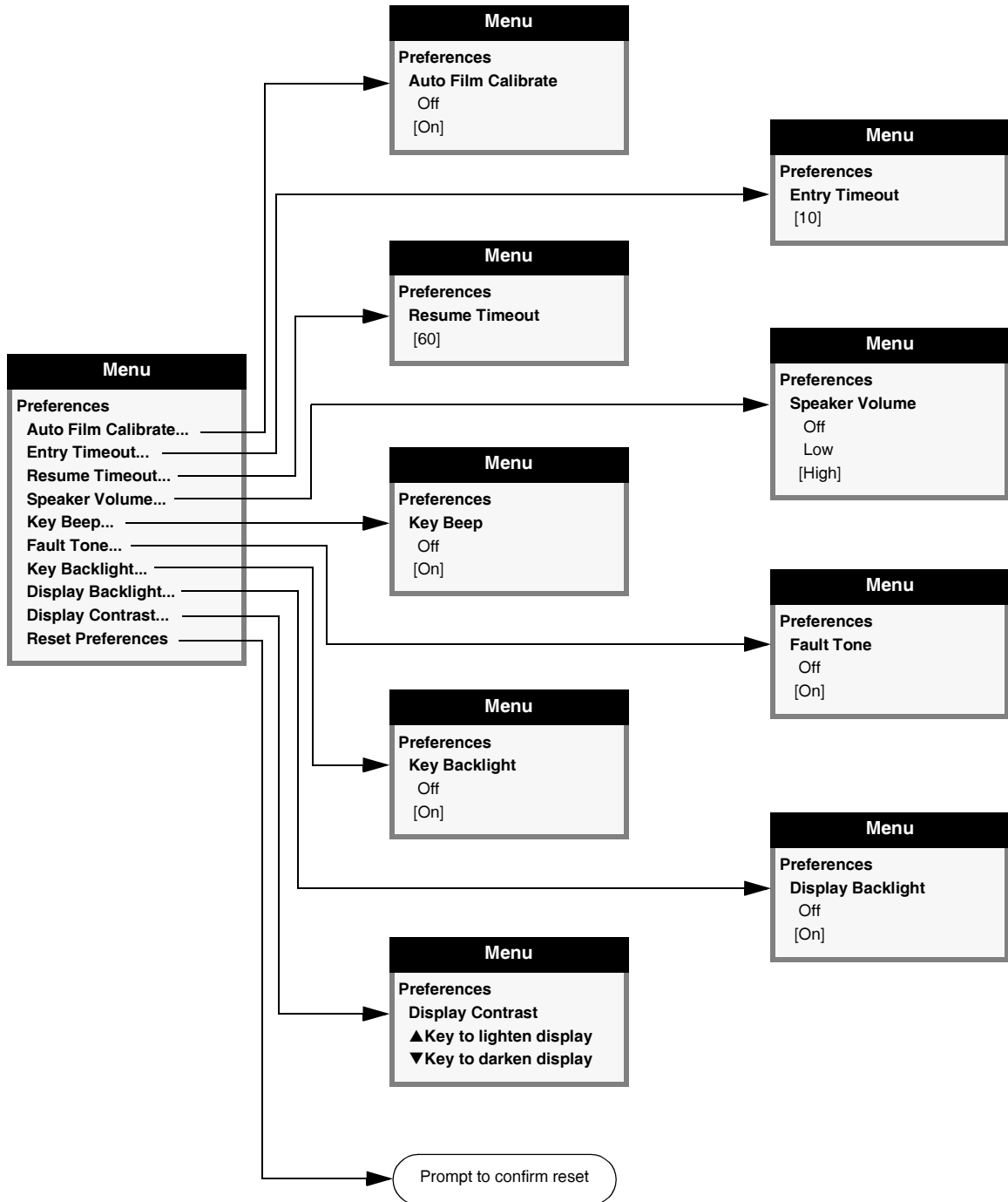

B

Specifications

Specifications (English)

Print Technology:	Dye-diffusion and direct thermal
Resolution:	319.5 dpi (12.6 pixels/mm)
Throughput:	Up to 100 films per hour
Grayscale	
Contrast Resolution:	12 bits (4096)
Color Resolution:	16.7 million colors, 256 levels each of cyan, magenta, and yellow
Media Inputs:	3 supply cassettes, 50–100 sheets each; 1 color ribbon
Media Outputs:	3 receive trays; 50-sheet capacity each
Media Sizes: (model specific)	8 x 10-in. 11 x 14-in. 14 x 17-in. A-Size Paper/White Film A-4 Size Paper/White Film <i>Horizon XL only:</i> 14 x 36-in. 14 x 51-in.
Media Types:	DirectVista film (blue and clear) DirectVista grayscale paper/white film ChromaVista color paper/white film (optional)
Dmax:	≥ 3.0 OD with DirectVista film
Archival:	≥ 20 years for DirectVista film when stored under ANSI extended-term storage conditions

Supply Cassettes:	All media is pre-packaged and factory-sealed.
Interfaces:	10/100 Base-T Ethernet (RJ-45) 10/100/1000 Base-T Ethernet (on some hardware variations) Serial diagnostic port UPS monitor port
Network Protocols:	Standard: FTP, LPR Optional: DICOM, Windows networking printing
Image Formats:	Standard: TIFF, GIF, PCX, BMP, PGM, PPM, XWD, JPEG, PNG, SGI (RGB), Sun Raster (RAS), Targa (TGA) Optional: DICOM, PostScript compatibility
Image Quality:	Automatic calibration using built-in densitometer
Image Control:	Contrast, Gamma, Medical Color Matching (MCM), Nudge, Polarity, Rotate, Saturation, Scaling
Sheet Control:	Background, Border Fill, Captions, Coverage, Image Warning, Dmax, Dmin, Film View, Look-Up Tables (LUT)
Sheet Formatting:	Variable Multiformatting™ (VMF™), Fixed Multiformatting (FMF), 35mm Slidemaker™
Control Panel:	Large, backlit LCD display Status lights: Online, Alert, Fault, and Activity Power and menu navigation buttons
Processor:	Intel
Memory:	256-MB RAM or greater
Hard Disk:	10 GB or greater (8 GB available for spooling)
Removable Media:	100-MB Zip Disk or USB flash drive for software upgrades
Smart Card:	16 KB or greater for storing configuration data
Power:	Universal Input: 100–120/200–240 V~ 47/63 Hz 600 W printing, 150 W idle
Weight:	35.8 kg (79 lbs)
Engine Dimensions:	36.8 cm H, 52.1 cm W, 61 cm L (14.5 in. H, 20.5 in. W, 24 in. L)

Environment: **Operating:**
Altitude: 700 to 1060 hPa (0.7 to 1.05 atm)
Temperature: 15 to 30 °C (59 to 86 °F)
Ambient temperature
for maximum print
speed: 22.2 °C (72 °F)
Humidity: 10% to 80% noncondensing

Shipping and Storage:

Altitude: 500 to 1060 hPa (0.5 to 1.05 atm)
Temperature: -22.2 to 50.6 °C (-8 to 123 °F)
Humidity: 5% to 85% noncondensing

Intentional Transmitters: Horizon transmits radio frequency energy at 13.56 MHz using ASK modulation. Maximum Effective Radiated Power: 200mW

Medical Compliance and Regulatory: FDA cleared to market per 510(k) K021054 and K060440, Class I MDR CE, GMP/QSR, and Regulatory: ISO13485: 2003, Safety IEC 60601-1, EMC IEC 60601-1-2 Class A for Professional Healthcare facilities

Laser Classification: Class I laser product according to IEC 60825-1 and 21 CFR 1040.10 and 1040.11.

FDA Classification: Class 2 equipment, Product Code LMC, Medical image hardcopy device

IEC 60601-1 Classification: Class I equipment, type ordinary IXPO continuous with intermittent loading



CAUTION Federal law restricts this device to be sold for use by or on the order of a physician.

Specifications (French)

<i>Technologie d'impression:</i>	<i>Dye-diffusion et thermique direct (sec, sécurité à la lumière du jour)</i>
<i>Résolution spatiale:</i>	<i>319.5 DPI (12,6 pixels/mm)</i>
<i>Débit:</i>	<i>Jusqu'à 100 films par heure</i>
<i>Résolution de contraste niveaux de gris:</i>	<i>12 bits (4096)</i>
<i>Résolution en couleur:</i>	<i>16,7 millions de couleurs 256 niveaux de chaque cyan, magenta et jaune</i>
<i>Entrées Media:</i>	<i>Trois cassettes d'approvisionnement, 50-100 feuilles Chacune; une ruban couleur</i>
<i>Sortie Media:</i>	<i>Trois plateaux de réception, capacité 50 feuilles pour chaque plateau</i>
<i>Tailles:</i>	<i>8 x 10-in. 11 x 14-in. 14 x 17-in. A paper/film blanc A4 paper/film blanc Horizon XL seulement: 14 x 36-in. 14 x 51-in.</i>
<i>Types de Media :</i>	<i>(bleu et clair) DirectVista film en niveaux de gris DirectVista papier ChromaVista paper/film blanc, couleur</i>
<i>Dmax:</i>	<i>≥ 3.00 avec DirectVista Film</i>
<i>Archivage:</i>	<i>≥ 20 ans avec DirectVista Film, en accord avec la norme ANSI étendu des termes sur les conditions de stockage</i>
<i>Cassettes d'approvisionnement:</i>	<i>Tous les supports sont préemballés et scellés en usine.</i>
<i>Interfaces:</i>	<i>Standard: 10/100 Base-T Ethernet (RJ-45) 10/100/1000 Base-T Ethernet (sur quelques variations) Port Série de diagnostique Console Série</i>

<i>Protocoles réseau:</i>	<i>Standard: FTP, LPR Facultatif: DICOM (jusqu'à 24 connexions simultanées), impression en réseau Windows</i>
<i>Formats d'images:</i>	<i>Standard: TIFF, GIF, PCX, BMP, PGM, PPM, XWD, JPEG, PNG, SGI (RGB), Sun Raster, Targa Facultatif: DICOM, compatibilité PostScript</i>
<i>Qualité de l'image:</i>	<i>Calibration automatique en utilisant un densitomètre embarqué</i>
<i>Contrôle d'image:</i>	<i>Gamma, contraste, saturation, Medical Color Matching (MCM), polarité, rotation, échelle, anticrénelage</i>
<i>Contrôle du média:</i>	<i>Ajustement de densité (Dmax) (Dmin), Look-Up Tables (LUT), avertissements images, cartouches, couverture du média, couleur de la bordure, remplissage des bordures</i>
<i>Mise en page Media:</i>	<i>Multi-Formatage Variable (VMF), Multi-Formatage Fixe (FMF), 35mm Slidemaker</i>
<i>Panneau de contrôle:</i>	<i>Grand afficheur LCD rétro-éclairé, état des voyants en ligne, alerte, erreur, alimentation active et menu avec boutons de navigation</i>
<i>Processeur:</i>	<i>Intel</i>
<i>Mémoire:</i>	<i>256 MB de RAM ou supérieur</i>
<i>Disque durs:</i>	<i>>10 GB (8 GB disponible pour la file d'attente)</i>
<i>Disque amovible:</i>	<i>100 MB disque Zip Disk ou Clé USB pour les mises à jour logicielles</i>
<i>Smart Card:</i>	<i>16 KB pour stocker des données de configuration</i>
<i>Puissance:</i>	<i>Entrée universelle: 100-120/200-240 V ~ 47/63 Hz, 600 W impression, 150 W en attente</i>
<i>Poids:</i>	<i>35.8 kg (79 lbs).</i>
<i>Dimensions:</i>	<i>36.8 cm H, 52.1 cm W, 61 cm L (14.5 in. H, 20.5 in. W, 24 in. L)</i>

Conditions du travail: **De fonctionnement:**
Altitude: 700 to 1060 hPa (0.7 to 1.05 atm)
Température: 15 to 30°C (59 to 86°F)
Température ambiante
pour la vitesse
d'impression maximale: 22.2°C (72°F)
Humidité: 10% to 80% sans condensation

Transport et Stockage:
Altitude: 500 to 1060 hPa (0.5 to 1.05 atm)
Température: -22.2 to 50.6°C (-8 to 123°F)
Humidité: 5% to 85% sans condensation

Émetteurs
Intentionnels: Horizon transmet l'énergie radiofréquence à 13,56 MHz
en utilisant la modulation ASK. Puissance rayonnée effective
maximale: 200mW

Conformité Médical
et Réglementation: Le respect intégral des dispositifs médicaux de classe 2, y
compris la FDA et de la classe 1 MDR CE, GMP / QSR,
ISO13485: 2003, 60601-1 de sécurité et EMC IEC 60601-1-2
Classe A pour les établissements de soins de santé
professionnels

Classification Laser: Produit laser de Classe I selon IEC 60825-1 et 21 CFR
1040.10 et 1040.11.

Classification FDA: Equipement de classe 2 Code Produit, LMC, Equipement de
production de clichés médicaux

Classification
IEC 60601-1: Equipement de Classe I, type IXPO ordinaire, continu avec
chargement intermittent



ATTENTION La loi fédérale restreint cet appareil à être vendus pour une utilisation
par ou sur ordre d'un médecin.



System Job Settings Files

The table on the following pages lists the system Job Settings files that come with the Horizon imager. Note that there is a system Job Settings file for each supported media type and size combination. As such, they contain only the Media Type and Media Size parameters.

The DefaultGrayscale and DefaultColor system Job Settings files contain no sheet or image parameters and, if used, cause the imager to default to the Default User Settings for Grayscale and Color, set at the control panel.

System Job Settings File	Corresponding Use
Print_SCP	<p>Used for DICOM. Does not contain any print parameter settings.</p> <p>If the media type or size is not included in the DICOM attributes sent to the imager, the imager detects the image type and selects the media type and size as follows:</p> <ul style="list-style-type: none"> • For grayscale images, uses the media set for Grayscale in the Default Media menu at the control panel. • For color images, uses the media set for Color in the Default Media menu at the control panel.
DefaultGrayscale	Imager uses the media set for Grayscale in the Default Media menu at the control panel
DefaultColor	Imager uses the media set for Color in the Default Media menu at the control panel
8x10-dvf	8x10 DirectVista film (blue)
8x10-dvfb	8x10 DirectVista film (blue)
8x10-dvfc	8x10 DirectVista film (clear)
8x10-dvp	8x10 DirectVista paper/white film
11x14-dvf	11x14 DirectVista film (blue)
11x14-dvfb	11x14 DirectVista film (blue)
11x14-dvp	11x14 DirectVista paper/white film
14x17-dvf	14x17 DirectVista film (blue)
14x17-dvfb	14x17 DirectVista film (blue)
14x17-dvfc	14x17 DirectVista film (clear)
14x17-dvp	14x17 DirectVista paper/white film
14x36-dvf	14x36 DirectVista film (blue)
14x36-dvfb	14x36 DirectVista film (blue)
14x51-dvf	14x51 DirectVista film (blue)
14x51-dvfb	14x51 DirectVista film (blue)
a-dvp	A-size DirectVista paper/white film

System Job Settings File	Corresponding Use
a-cvp	A-size ChromaVista paper/white film
a4-dvp	A4-size DirectVista paper/white film
a4-cvp	A4-size ChromaVista paper/white film
priority-high	Sets print job priority to high
priority-medium	Sets print job priority to medium
priority-low	Sets print job priority to low
receive-1	Forces sheet output to receive tray 1
receive-2	Forces sheet output to receive tray 2
receive-3	Forces sheet output to receive tray 3
syngofilm	Special OEM-specific job settings

D

Print Job Parameters

The tables on the following pages provide summaries of the print job parameters that can be changed using the Default Media, Default User Settings, and Custom Job Settings menus at the control panel; Job Settings files; and backup media **settings.txt** files.

The tables are broken down by job-, sheet-, and image-related parameters.



NOTE: *Border Fill, Coverage, LUT, and Rotate are considered advanced parameters and should be changed only by a key operator.*

For a complete explanation of the print job parameters, refer to the *Horizon Imager Technical Manual*.

Table D-1. Job Parameters

Parameter	Description	Possible Values	Default	DirectVista Film—Blue	DirectVista Film—Clear	DirectVista Paper/White Film	ChromaVista Paper/White Film
Media Size	Size of the selected media to use.	DirectVista Film (Blue or Clear): <ul style="list-style-type: none"> • 8x10 • 11 x 14 • 14 x 17 • 14 x 36 • 14 x 51 DirectVista Paper/White Film: <ul style="list-style-type: none"> • 8x10 • 11 x 14 • 14 x 17 • A • A4 ChromaVista Paper/White Film: <ul style="list-style-type: none"> • 8x10 • A • A4 	Default Media set at the control panel. Sizes 14 x 36 and 14 x 51 available only in blue film.	✓	✓	✓	✓
Media Type	DirectVista paper/white film or film, ChromaVista paper/white film.	DV Film Blue DV Film Clear DV Paper CV Paper	Default Media set at the control panel.	✓	✓	✓	✓
Priority	Priority of job sent to imager. Higher priority jobs are printed first. <i>NOTE: Not settable in Default User Settings at the control panel.</i>	Low, Medium, or High	Medium	✓	✓	✓	✓
Receive Tray	Which receive tray to output sheets. <i>NOTE: Not settable in Default User Settings at the control panel.</i>	1, 2, or 3	Receive tray that corresponds to the source supply slot.	✓	✓	✓	✓

Table D-2. Sheet Parameters

Parameter	Description	Possible Values	Default	DirectVista Film—Blue	DirectVista Film—Clear	DirectVista Paper/White Film	ChromaVista Paper/White Film
Background	Color that fills the non-image areas of the sheet.	White Light Gray Medium Gray Dark Gray Black	Black (for film) White (for paper/ white film)	✓	✓	✓	✓
Border Fill	If On, the border area is filled with the currently defined background color. <ul style="list-style-type: none"> • DirectVista paper: setting is ignored • DirectVista film: border falls just inside edges of sheet • ChromaVista: border prints slightly off sheet edges <p>Not relevant with Coverage setting set to Full Bleed.</p>	Off On	On (for film) Off (for paper/ white film)	✓	✓		✓
Captions	If On, enables printing of captions on the sheet.	Off On	On	✓	✓	✓	✓
Coverage	Determines whether there will be a border between images and edges of the sheet, or images will bleed off the sheet edges.	Standard (some border area around edge of sheet) Full bleed (setting valid only for ChromaVista color paper/white film only; outside edges of images will bleed off sheet edges) NP (imager emulates 300 dpi resolution; for NP-series imager legacy support)	Standard	✓	✓	✓	✓

Table D-2. Sheet Parameters (cont.)

Parameter	Description	Possible Values	Default	DirectVista Film—Blue	DirectVista Film—Clear	DirectVista Paper/White Film	ChromaVista Paper/White Film
Dmax	<p>Maximum image density value.</p> <p>This setting has the greatest effect on the gray-levels closer to black. Higher settings increase the density of the dark portion of the image. Lower settings decrease the density of the dark portion of the image.</p> <p>Typical settings range from 250 (lightest) to 310 (darkest).</p> <p>Dmax should be set before other settings (such as Gamma and Contrast) are adjusted. Refer to Chapter 8.</p> <p>NOTE: If the Dmax setting is higher than the film can produce, the film's maximum Dmax setting will be used.</p>	<p>100 (lightest) to 310 (darkest)</p> <p>NOTE: Values from 311 up to 400 can be set; however, they will be mapped to 310.</p>	300	✓	✓		
Dmin	<p>Minimum image density value.</p> <p>This setting has the greatest effect on the gray-levels closer to white. Higher settings increase the density of the light portion of the image. Lower settings decrease the density of the light portion of the image.</p> <p>Typically, Dmin is left at 0.</p> <p>NOTE: If the Dmin setting is lower than the film can produce, the film's minimum Dmin setting will be used</p>	<p>0 (lightest) to 100 (darkest)</p>	0	✓	✓		
Film View	<p>The direction from which the film is viewed once printed.</p>	<p>Front (film viewed from the emulsion side)</p> <p>Back (film viewed from the non-emulsion side)</p>	Front	✓	✓		

Table D-2. Sheet Parameters (cont.)

Parameter	Description	Possible Values	Default	DirectVista Film—Blue	DirectVista Film—Clear	DirectVista Paper/White Film	ChromaVista Paper/White Film
Image Warnings	<p>Image decimation occurs if pixels are removed from an image so that it can fit in its cell area on the sheet.</p> <p>If set to On and image decimation occurs, the message “Warning: Image Decimated” is printed on the corner of the decimated image.</p>	Off On	On	✓	✓	✓	✓
LUT	Determines which look-up table will be used on the images on a sheet. Look-up tables are customized data curves that affect an image’s appearance.	<p>Visual (visually linear output)</p> <p>Linear (measurably linear output, via a densitometer)</p> <p>Custom1 through Custom9 (assigned to custom LUTs created by OEM vendors)</p>	Visual	✓	✓	✓	✓

Table D-3. Image Parameters

Parameter	Description	Possible Values	Default	DirectVista Film—Blue	DirectVista Film—Clear	DirectVista Paper/White Film	ChromaVista Paper/White Film
Antialias	<p>Function that smooths out jaggy edges of image objects.</p> <p>Can eliminate artifacts and improve appearance, especially when printing text or graphic objects with hard edges.</p> <p><i>NOTE: Only settable from PostScript printing options, accessible in the sending application.</i></p> <p><i>Not settable at the control panel, in Job Settings files, or in backup media settings.txt files.</i></p>	<p>None (no antialiasing is performed)</p> <p>Better (a compromise between antialiasing quality and print speed)</p> <p>Best (highest antialiasing quality, but requires the most processing time.)</p>	None	✓	✓	✓	✓
Contrast	<p>Allows you to expand and contract the distribution of pixel densities within an image.</p> <p>Higher contrast makes light portions of an image lighter and dark portions darker. Lower values make light and dark portions more neutral.</p> <p>Typical settings range from -10 (reduced contrast) to +25 (increased contrast). 0 = no adjustment.</p>	<p>-80 to 80</p> <p><i>NOTE: Values from -100 up to -81 and from 81 up to 100 can be set; however, they will be mapped to -80 and 80, respectively.</i></p>	0	✓	✓	✓	✓
Gamma	<p>Allows you to adjust the overall darkness of an image.</p> <p>Higher settings lighten the image, and lower settings darken the image.</p> <p>Typical settings range from 0.8 (darkest) to 2.0 (lightest). 1.0 = no adjustment.</p>	<p>0.5 to 10.0</p> <p><i>NOTE: For NP-series imager legacy support, negative settings from -10 to -0.5 can be used to specify negative polarity and the gamma setting (gamma is absolute value of the setting value).</i></p>	1.0	✓	✓	✓	✓

Table D-3. Image Parameters (cont.)

Parameter	Description	Possible Values	Default	DirectVista Film—Blue	DirectVista Film—Clear	DirectVista Paper/White Film	ChromaVista Paper/White Film
MCM	Medical Color Matching. When enabled, algorithms are applied to the image data before printing so that printed images match those displayed on a monitor.	0 = MCM disabled 1 = Sony Trinitron 2 = ViewSonic G810 3 = NEC MultiSync 1880SX 4 = NEC MultiSync 1880SX Alternate 1 5 = Sony Trinitron Alternate 1 6 = NP-1600 MCM 6 Equivalent 7 = ViewSonic G810 Alternate 1 8 = Sun Monitor 1 9 = 3D rendering, CRT Monitors 10 = 3D rendering, LCD Monitors 11 to 17 = future use 100 to 999 = OEM-specific custom settings	0				✓
Nudge		Adjusts the position of an image on the film by up to 20 pixels (1.6 mm) in any direction. <i>NOTE: The Nudge parameter is valid for DICOM printing only.</i>		✓	✓	✓	✓
Polarity	Inverts the pixel values of an image between Positive (no adjustment) and Negative (reverses the polarity). Negative polarity can be useful in certain applications such as nuclear medicine.	Positive Negative	Positive	✓	✓	✓	✓

Table D-3. Image Parameters (cont.)

Parameter	Description	Possible Values	Default	DirectVista Film—Blue	DirectVista Film—Clear	DirectVista Paper/White Film	ChromaVista Paper/White Film
Rotate	Specifies whether image should be rotated 90° counterclockwise on the sheet.	Auto (rotate image to make as large as possible)	Auto	✓	✓	✓	✓
	Only valid if printing a scaled single-image sheet (logical device 2).	Never Always					
Saturation	A property of color that specifies how far a color is from a gray tone of the same density. Negative settings reduce saturation, positive numbers increase saturation (-100 = no color; 0 = no adjustment; 100 = full color). Typical settings to add vibrancy to an image are 0 to 50.	-100 to 100 <i>NOTE: For NP-series imager legacy support, TCR values from 0 to 100 are mapped to Saturation values -100 to 0.</i>	0				✓

Table D-3. Image Parameters (cont.)

Parameter	Description	Possible Values	Default	DirectVista Film—Blue	DirectVista Film—Clear	DirectVista Paper/White Film	ChromaVista Paper/White Film
Scaling	Specifies which scaling filter will be used if scaling is applied to an image as part of a print job.	<p>None Performs no scaling or magnification; available only via DICOM.</p> <p>Bilinear [uses linear interpolation; provides very good scaling for most applications for which scale factors are relatively small (4X or less)]</p> <p>Mitchell (uses a cubic Mitchell function; very smooth output while maintaining dynamic range and sharpness; for any scaling application, especially when scaling factors are 2X or greater)</p>	Lanczos	✓	✓	✓	✓

Table D-3. Image Parameters (cont.)

Parameter	Description	Possible Values	Default	DirectVista Film—Blue	DirectVista Film—Clear	DirectVista Paper/White Film	ChromaVista Paper/White Film
Scaling (cont.)		<p>Bicubic (uses a cubic B-spline function; smoothest output, but tends to smooth over fine details; use when smoothest output is required)</p> <p>Lanczos (uses a sinc function; most theoretically correct filter; produces best output for photographic images without sharp transitions)</p> <p>Box (uses pixel replication; for images containing text with block letters in which the text must remain sharp)</p> <p>Sharp1 (uses a mild edge enhancement function)</p> <p>Sharp2 (uses a moderate edge enhancement function)</p> <p>Sharp3 (uses a strong edge enhancement function)</p>	Lanczos	✓	✓	✓	✓

Index

Numerics

- 10/100 Base-T
Ethernet hubs, 2-8

A

- Active indicator, 3-11
- administrative menu options, 3-14
- Alert indicator, 3-4, 3-11, 12-1
- Antialias image parameter, D-6
 - setting in Macintosh PostScript, 6-21
 - setting in Windows PostScript, 6-6
- arrow keys, 3-16
- arrow selector in menus, 3-14

B

- Background sheet parameter, D-3
 - setting in Macintosh PostScript, 6-23
 - setting in Windows PostScript, 6-7
- backing up imager, 1-6
- Backup media
 - managing backups to, 2-23
- backup media
 - differences due to hardware, -xli
 - restoring configuration settings from, 2-24
 - saving configuration settings to, 2-20
 - uses, 1-6
- backups, managing, 2-23
- barcode
 - "barcode error" message, 3-5, 12-12
 - entering manually, 12-26 to 12-28
- Barcode Reader Cleaning Kit, 10-2

- barcode reader window
 - cleaning, 10-15 to 10-18
 - cleaning schedule, 10-1
- base IP address for Horizon imager, 2-16
- basement, 2-6
 - cleaning, 10-19
 - scratches, 2-6
- basic imager operations, 3-1 to 3-23
- Bicubic scaling filter, D-10
- Bilinear scaling filter, D-9
- BMP image format, 1-4
- Border Fill sheet parameter, D-3
 - setting in Macintosh PostScript, 6-22
 - setting in Windows PostScript, 6-8
- Box scaling filter, D-10
- Bracketing function, 9-1
- bracketing sheets
 - definition, 9-3, 9-9
 - gamma/contrast sample sheet, 9-4
 - general guidelines for use, 9-2
 - MCM sample sheet, 9-10
 - printing GCS (GCT) sheet via PostScript, 9-5
 - printing GCS sheets from DICOM, 9-4
 - printing MCM sheets from DICOM, 9-11
 - printing MCM sheets via PostScript, 9-11
- brackets in menus, 3-20, 3-21
- break-off leaders, 4-7

C

- calibration
 - "calibrating film" message, 3-5, 12-12
 - "film calibration failed" message, 3-5, 12-12
 - film calibration schedule, 10-2
 - internal densitometer calibration schedule, 10-2
 - thermal print head calibration schedule, 10-2

- Called AE Titles
 - Job Settings files, using to specify, 5-7
 - listing and descriptions, 5-4
 - Cancel key, 3-17
 - cancel print jobs, 12-25
 - cancelling changes on a menu screen, 3-21
 - captions
 - adding to printed sheets, 1-5
 - Captions sheet parameter, D-3
 - setting in Macintosh PostScript, 6-22
 - setting in Windows PostScript, 6-8
 - cassettes
 - "checking cassettes" message, 3-5, 12-12
 - "no cassette" message, 3-5, 12-13
 - barcode, 4-2
 - changing, 4-4 to 4-5
 - clearing a jam, 12-16
 - entering barcode manually, 12-26 to 12-28
 - loading media, 2-17
 - media, 4-1 to 4-3
 - specifying which to use, 4-6
 - status messages, 3-5, 12-12
 - supply slots, 4-2
 - troubleshooting, 12-9
 - Category 5, RJ-45 cables, 2-8
 - changing a supply cassette, 4-4 to 4-5
 - ChromaVista color media
 - adjusting image appearance, 9-7
 - and grayscale images, 9-1
 - break-off leaders, 4-7
 - changing the ribbon, 4-8 to 4-11
 - destroying the ribbon, 4-11
 - dye-diffusion process, 1-2
 - imaging applications, 1-2
 - ribbon status indications, 3-6, 12-13
 - types and sizes, 4-12
 - use precautions, -xxxviii
 - cleaning kits
 - ordering, 10-2
 - cleaning precautions, -xxxvii
 - cleaning procedures, general, 10-18 to 10-19
 - CMY indicator, 3-4
 - CNFG (configuration) label, -xxv
 - Codonics
 - anonymous FTP site, 12-31
 - email address, -xvi
 - phone numbers, -xvi, 4-13, 10-2
 - product information, -xvi
 - technical support, 12-30
 - web site, 4-13, 10-2
 - color management
 - precautions, -xl
 - color media, *see* ChromaVista color media
 - color ribbon
 - status indications, 3-6, 12-13
 - troubleshooting, 12-9
 - compliance label, -xxiv
 - location, -xvii
 - components, safe to touch, -xxxii, -xxxiv
 - compress command, UNIX and Linux, 12-32
 - Conducted Emissions, -xxix
 - Conducted Immunity, -xxx
 - confidentiality, patient, 4-11
 - configuration number, -xxv
 - configuration settings
 - managing backups, 2-23
 - restoring, 2-24
 - saving, 2-20 to 2-22
 - connecting the imager, 3-2
 - connectors, 3-2
 - console connector, 3-2
 - Contrast image parameter, D-6
 - setting in Macintosh PostScript, 6-23
 - setting in Windows PostScript, 6-7
 - contrast, adjusting, 9-5, 9-7
 - control panel
 - illustration, 3-10
 - imager operating status, 12-1
 - indicators, 3-11
 - keys, 3-16 to 3-17
 - menu conventions, 3-21
 - navigating, 3-18 to 3-21
 - conventions used in this manual, -xi to -xiv
 - Copy Count parameter, setting in Windows PostScript, 6-6
 - Coverage sheet parameter, D-3
 - Crop Margin parameter
 - setting in Macintosh PostScript, 6-21
 - setting in Windows PostScript, 6-7
 - crossover cable, 2-9
- ## D
- date code, -xxv
 - default print job settings, 8-1 to 8-8
 - Default User Settings
 - changing, 8-5 to 8-6

- resetting to factory defaults, 8-8
- DefaultColor Job Settings file, C-2
- DefaultGrayscale Job Settings file, C-2
- DEFF image format, 1-4
- delete print jobs, 12-25
- DICOM
 - conformance statement, 5-2
 - definition, 5-1
 - image format, 1-4
 - Print Service Class Provider, 5-3
 - Print Service Class User, 5-3
- DICOM applications
 - configuring, 5-4
 - Job Settings, specifying for, 5-6
 - printing from, 1-3, 5-1 to 5-8
 - simultaneous connections, 1-3
 - specifying media type and size, 5-5
- DirectVista grayscale media
 - adjusting image appearance, 9-5
 - direct thermal technology, 1-2
 - film calibration, 11-2
 - imaging applications, 1-2
 - optical density of images, 1-5
 - types and sizes, 4-12
 - use precautions, -xxxviii
- disposal requirements, -xlii
- Dmax sheet parameter, D-4
 - setting in Macintosh PostScript, 6-22
 - setting in Windows PostScript, 6-7
- Dmax, adjusting, 9-5, 9-7
- Dmin sheet parameter, D-4
 - setting in Macintosh PostScript, 6-22
 - setting in Windows PostScript, 6-7
- donor guide bar
 - cleaning procedure, 10-8 to 10-12
 - cleaning schedule, 10-1
- Driver Version job parameter
 - viewing in Macintosh PostScript, 6-21
 - viewing in Windows PostScript, 6-6
- dust, *see* cleaning procedures *and* troubleshooting
 - image quality
- dye-diffusion process, 1-2

E

- Electrical Fast Transient / Burst, -xxx
- Electromagnetic Emissions and Immunity, -xxviii
- Electromagnetic Emissions Standards and Test

- Levels, -xxix
- Electromagnetic Immunity Standards and Test
 - Levels, -xxix
- electronic emissions notices, -xxvii
- Electrostatic Discharge, -xxix
- ellipses (...) in menu option, 3-18, 3-21
- Enter key, 3-17
- error log, 12-1
 - viewing, 12-28
- ESD
 - caution, -xxvi
 - label, -xxvi
- Ethernet
 - cable jack, 2-8
 - connecting cable, 2-8
 - crossover cable, 2-9, 2-12
 - hub, 2-8, 2-9, 2-12
- European disposal requirements, -xlii
- Exif image format, 1-4
- exiting menus, 3-21

F

- factory defaults
 - print job settings, 8-7
- Fault indicator, 3-4, 3-11, 12-1
- Fault tone, 3-12
- file formats, 1-4
- file transfer
 - precautions, -xl
- film
 - path through imager, 12-15
 - see also* media
- film calibration, 11-1, 11-2
 - schedule, 10-2
- film jams
 - clearing, 12-14 to 12-21
 - troubleshooting, 12-6
- Film View sheet parameter, D-4
 - setting in Macintosh PostScript, 6-22
 - setting in Windows PostScript, 6-8
- Fixed Multiformating (FMF)
 - sheets, 7-3
- footprint of imager, 1-2
- front panel, *see* control panel
- FTP
 - anonymous, 12-31
 - file transfer precautions, -xl

- printing images, 1-3
- printing via, 7-1 to 7-4
- simultaneous connections, 1-4
- specifying media type and size, 7-4
- uploading files to Codonics site, 12-31 to 12-32

G

- Gamma image parameter, D-6
 - setting in Macintosh PostScript, 6-23
 - setting in Windows PostScript, 6-7
- gamma/contrast bracketing sheet, 9-3
- gamma/saturation bracketing sheet, 9-3
- gamma, adjusting, 9-5, 9-7
- gateway, 2-12
 - IP address for Horizon imager, 2-13
- GIF image format, 1-4
- grayscale images and ChromaVista color media, 9-1
- grayscale media, *see* DirectVista grayscale media
- gzip application, UNIX and Linux, 12-32

H

- hardware variations
 - precautions, -xli
- Harmonic Distortion, -xxix
- help
 - how displayed, 3-23
 - message area, 3-14
 - troubleshooting information, 12-1
- Help key, 3-17
- hide track, 2-6
- Horizon imager
 - adding to a simple network, 2-12
 - backup media, 1-6
 - base IP address, 2-16
 - basement, 2-6
 - basic operations, 3-1 to 3-23
 - Called AE Titles used, 5-4
 - changing default media type and size, 8-3 to 8-4
 - changing Default User Settings, 8-5 to 8-6
 - changing PostScript parameters from
 - Macintosh applications, 6-18 to 6-23
 - changing PostScript parameters in Windows, 6-4 to 6-16
 - cleaning precautions, -xxxvii
 - color management precautions, -xli
 - compliance, -xxiv
 - configuration number, -xxv
 - date code, -xxv
 - default print job settings, 8-1 to 8-8
 - electronic emissions notices, -xxvii
 - error log, 12-1
 - error log, viewing, 12-28
 - features, 1-1 to 1-6
 - file formats, 1-4
 - file transfer precautions, -xli
 - film calibration, 11-2
 - footprint, 1-2
 - front view, 3-1
 - general cleaning procedures, 10-18 to 10-19
 - hardware variations precautions, -xli
 - hide track, 2-6
 - hierarchy of print job parameters, 6-3
 - hierarchy of print job settings, 5-8
 - image processing capabilities, 1-5
 - image scaling precautions, -xli
 - indications for use, -xliii
 - installation media, 1-6
 - installing, 2-2 to 2-7
 - internal components safe to touch, -xxxii, -xxxiv
 - laser warnings, -xxi
 - location precautions, -xxxv
 - media use precautions, -xxxviii
 - models, 1-2
 - modification codes, -xxv
 - online help, 12-1
 - operational state indicators, 3-4
 - packaging, 2-2
 - Pause state, 3-22
 - pausing, 3-22
 - port number, 5-4
 - power key, 3-3
 - powering off, 3-7
 - powering on, 3-3
 - powering on for first time, 2-10
 - preparing for installation, 2-1
 - preparing for shipment, 2-26
 - preventive maintenance, 10-1 to 10-19
 - rear connectors, 3-2
 - rear view, 3-2
 - rebooting, 3-9
 - resetting Default User Settings to factory defaults, 8-8
 - resetting media type and size to factory defaults,

- 8-7
- restoring configuration settings, 2-24
- resuming printing, 3-23
- safety
 - precautions, -xxxi
- saving configuration settings, 2-20 to 2-22
- saving print settings as defaults in Macintosh OS 8 and 9, 6-24
- saving print settings as presets in Macintosh OS X, 6-24
- selecting media from Macintosh applications, 6-16
- serial number label, -xxv
- Smart Card, 1-6
- Smart Card panel door, 2-3, 2-21
- specifications, B-1 to B-6
- specifying IP addresses, 2-13 to 2-17
- Status test print, printing, 2-18
- swapping for service reasons, 2-25
- technical support, 12-30
- temperature warnings, -xxiii
- troubleshooting, 12-1 to 12-32
- upgrading features, 1-5
- viewing information about, 12-29
- voltage warnings, -xviii

hubs, Ethernet, 2-8

I

- image file formats, 1-4
- image parameters
 - Antialias, D-6
 - changing defaults, 8-5 to 8-6
 - Contrast, D-6
 - Gamma, D-6
 - MCM, D-7
 - Polarity, D-7
 - Rotate, D-8
 - Saturation, D-8
 - Scaling, D-9
- image processing capabilities, 1-5
- image quality
 - optimizing with calibrations, 11-1
- image scaling
 - precautions, -xli
- image settings, 1-5
- Image Warnings sheet parameter, D-5
 - setting in Macintosh PostScript, 6-22

- setting in Windows PostScript, 6-8
- Imager Info screen, 12-29
- Imager Status test print
 - as information source, 12-2
 - printing, 2-18
- images
 - adjusting appearance, 2-20, 9-1 to 9-8
 - adjusting appearance on ChromaVista color media, 9-7
 - adjusting appearance on DirectVista grayscale media, 9-5
 - enhancing appearance, 2-20
 - grayscale images and ChromaVista color media, 9-1
 - quality troubleshooting, 12-7
 - viewing guidelines, 9-2
- indications for use of the imager, -xliii
- indicators
 - Alert, 3-4, 12-1
 - CMY, 3-4
 - color ribbon status, 3-6, 12-13
 - control panel, 3-11
 - Fault, 3-4, 12-1
 - network activity, 3-2
 - network speed, 3-2
 - OK, 3-4
 - ribbon, 3-4
- installation
 - preparing for, 2-1
- installation media
 - differences due to hardware, -xli
- interference, radio and television, -xxvii
- internal components safe to touch, -xxxii, -xxxiv
- internal densitometer calibration, 11-1
 - schedule, 10-2
- IP addresses
 - format, 2-13
 - Horizon base address, 2-16
 - specifying for Horizon imager, 2-13 to 2-17
 - specifying for other devices on the network, 2-17

J

- jams
 - clearing, 12-14 to 12-21
 - troubleshooting, 12-6
- JFIF image format, 1-4
- job parameters

- Media Size, D-2
- Media Type, D-2
- Priority, D-2
- Receive Tray, D-2
- Job Settings files
 - custom, 5-6
 - specifying, 5-6 to 5-8
 - system, 5-6, C-1 to C-3
- JPEG image format, 1-4

K

- keys
 - control panel, -xii, 3-16 to 3-17

L

- LAN, *see* local area networks
- Lanczos scaling filter, D-10
- laser warnings, -xxi
- leaders, ChromaVista color media, 4-7
- LEDs, *see* indicators
- license code
 - viewing, 12-29
 - where found, 12-30
- Linux
 - compress command, 12-32
 - gzip application, 12-32
 - tar command, 12-32
- loading cassettes, 4-4 to 4-5
- loading media, 4-4 to 4-5
- loading ribbon, 4-8 to 4-11
- local area networks (LAN), 2-12
- location precautions, -xxxv
- log files
 - error log, 12-1
- LPR
 - file transfer precautions, -xl
 - printing images, 1-3
 - printing via, 7-5 to 7-6
 - simultaneous connections, 1-4
 - specifying media type and size, 7-6
- LUT sheet parameter, D-5
 - setting in Macintosh PostScript, 6-22
 - setting in Windows PostScript, 6-8

M

- Macintosh
 - StuffIt application, 12-32
- Macintosh applications
 - changing PostScript parameters, 6-18 to 6-23
 - PostScript printing from, 6-16 to 6-24
 - saving print settings as defaults in OS 8 and 9, 6-24
 - saving print settings as presets in OS X, 6-24
 - selecting media, 6-16
- Magnetic Field Immunity, -xxx
- Main Menu, 3-14
 - displaying administrative options, 3-14
- maintenance
 - recommended schedule, 10-1
- Margin Size parameter
 - setting in Macintosh PostScript, 6-22
 - setting in Windows PostScript, 6-7
- MCM bracketing sheet, 9-9
- MCM image parameter, D-7
 - setting in Macintosh PostScript, 6-23
 - setting in Windows PostScript, 6-7
- MCM, *see* Medical Color Matching
- media
 - "calibrating film" message, 3-5, 12-12
 - "checking cassette" message, 3-5, 12-12
 - "contaminated" message, 3-5, 12-12
 - "film calibration failed" message, 3-5, 12-12
 - "media jam" message, 3-5, 12-12
 - "no cassette" message, 3-5, 12-13
 - "printing" message, 3-5, 12-13
 - "unsupported" message, 3-5, 12-13
 - break-off leaders for ChromaVista color media, 4-7
 - cassette-related messages, 3-5, 12-12
 - cassettes, 4-1 to 4-3
 - changing default size and type, 8-3 to 8-4
 - changing Default User Settings for media type, 8-5 to 8-6
 - ChromaVista color media and grayscale images, 9-1
 - color, 1-3
 - grayscale, 1-3
 - handling and storage, 4-1 to 4-13
 - loading cassettes, 2-17
 - ordering, 4-12 to 4-13
 - path through imager, 12-15

- resetting Default User Settings to factory defaults, 8-8
- resetting type and size to factory defaults, 8-7
- selecting from Macintosh applications, 6-16
- selecting from Windows 2000 and XP applications, 6-15
- selecting from Windows 98 and Me applications, 6-9
- selecting from Windows NT applications, 6-12
- setting type and size using FTP, 7-4
- setting type and size using LPR, 7-6
- setting type and size via DICOM, 5-5
- setting type and size via PostScript, 6-3
- size, type, and count status message, 3-5, 12-13
- supply slots, 4-2
- troubleshooting cassettes, 12-9
- troubleshooting jams, 12-6
- types and sizes, 1-3, 4-12
- use precautions, -xxxviii
- media guides, reinstalling, 12-22
- Media Size job parameter, D-2
- Media Type job parameter, D-2
- Medical Color Matching (MCM)
 - definition, 9-9
- menu hierarchies, A-1
- Menu key, 3-16
- menu options
 - control panel, -xii
- menu paths, -xii
- menus
 - cancelling changes, 3-21
 - conventions, 3-21
 - ellipses (...) in menu option, 3-18, 3-21
 - exiting, 3-21
 - scroll indicator, 3-14
 - square brackets, 3-20, 3-21
- misfeeds, 12-14 to 12-21
- Mitchell scaling filter, D-9
- modem, 2-9
- modem connectors, 3-2
- modification codes, -xxv

N

- navigating the control panel, 3-18 to 3-21
- network activity indicator, 3-2
- network connector, 2-8, 3-2

- network printing
 - testing, 2-19
- network speed indicator, 3-2
- networks
 - adding the Horizon imager, 2-12
 - simple, 2-12
- none scaling filter, D-9
- nosepiece
 - cleaning procedure, 10-3 to 10-7
 - cleaning schedule, 10-1

O

- OK indicator, 3-4
- Online indicator, 3-11
- opening the imager top cover
 - as part of cleaning procedure, 10-3
- operational state, 3-4
- ordering cleaning kits, 10-2
- ordering media, 4-12 to 4-13
- Orientation parameter, setting in Windows PostScript, 6-6
- Output Bin parameter
 - setting in Macintosh PostScript, 6-21
 - setting in Windows PostScript, 6-6

P

- packing the imager, 2-26
- Page Size parameter, setting in Windows, 6-6
- paper
 - path through imager, 12-15
 - see also* media
- paper jams
 - clearing, 12-14 to 12-21
 - troubleshooting, 12-6
- Paper Size parameter
 - choices in Macintosh PostScript, 6-21
- Paper Size parameter, setting in Windows PostScript, 6-6
- parts safe to touch, -xxxii, -xxxiv
- passwords
 - changing for service login, 2-20
 - for Codonics anonymous FTP site, 12-31
 - for FTP, using to specify Horizon logical device, 7-2

- patch cable, 2-9
- patient confidentiality, 4-11
- Pause key, 3-17
- Pause state, 3-22
- pausing the imager, 3-22
- PCX image format, 1-4
- pick tires
 - cleaning procedure, 10-13 to 10-15
 - cleaning schedule, 10-1
- pixelation, 1-5
- PKZIP, 12-32
- platen
 - cleaning procedure, 10-8 to 10-12
 - cleaning schedule, 10-1
- Platen and Print Head Cleaning Kit, 10-2
- PNM image format, 1-4
- Polarity image parameter, D-7
 - setting in Macintosh PostScript, 6-23
 - setting in Windows PostScript, 6-7
- port number, 5-4
- PostScript, 1-4
 - changing parameters from Macintosh, 6-18 to 6-23
 - changing parameters from Windows, 6-4 to 6-16
 - introduction, 6-2
 - printing from Macintosh applications, 6-16 to 6-24
 - printing from Windows applications, 6-4 to 6-16
 - printing via, 1-3, 6-1 to 6-24
 - saving print settings as defaults in Macintosh OS 8 and 9, 6-24
 - saving print settings as presets in Macintosh OS X, 6-24
 - selecting media from Macintosh applications, 6-16
 - settings that can be changed, 6-6, 6-21
 - simultaneous connections, 1-3
 - specifying media type and size, 6-3
- power key, 3-3
- Power menu, bypassing, 3-7
- power rocker switch, 2-10
- powering off the Horizon imager, 3-7
- powering on for first time, 2-10
- powering on the Horizon imager, 3-3
- precautions
 - cleaning, -xxxvii
 - color management, -xl
 - file transfer via FTP and LPR, -xl
 - hardware variations, -xli
 - image scaling, -xli
 - location, -xxxv
 - media use, -xxxviii
 - safety, -xxxix
- preventive maintenance, 10-1 to 10-19
 - recommended schedule, 10-1
- Print FMF After Job parameter
 - setting in Macintosh PostScript, 6-22
 - setting in Windows PostScript, 6-7
- print job parameters
 - resetting to factory default settings, 8-7
 - summary, D-1 to D-10
- print job settings
 - specifying, 5-6
- print jobs
 - purging, 12-25
- print length calibration, 11-1
- print parameters
 - default settings, 8-1 to 8-8
- print quality problems, 12-7
- Print Service Class Provider, 5-3
 - Called AE Title, 5-3
- Print Service Class User, 5-3
 - Calling AE Title, 5-3
- Print_SCP Job Settings file, C-2
- printer, *see* Horizon imager
- printing
 - from DICOM applications, 5-1 to 5-8
 - resuming, 3-23
 - troubleshooting, 12-2
 - via FTP, 7-1 to 7-4
 - via LPR, 7-5 to 7-6
 - via PostScript, 6-1 to 6-24
- Priority job parameter, D-2
 - setting in Macintosh PostScript, 6-23
 - setting in Windows PostScript, 6-8
- Proximity fields from RF wireless equipment, -xxx
- purge print jobs, 12-25
- purpose of User's Manual, -xv

Q

- quality problems with prints, 12-7

R

- Radiated RF Immunity, -xxx
- radio interference, -xxvi, -xxvii
- RAS image format, 1-4
- rebooting, 3-9
- Receive Tray job parameter, D-2
- receive trays
 - cleaning, 10-18
 - overview, 4-3
- removing jams, 12-14 to 12-21
- resuming printing, 3-23
- returning the imager to Codonics, 2-26
- RF Emissions, -xxix
- ribbon
 - changing, 4-8 to 4-11
 - destroying, 4-11
 - indicator, 3-4
 - loading, 2-17
- RJ-45 cables, Category 5, 2-8
- Rotate image parameter, D-8

S

- SA-2000, printing from, 1-3
- Safe Label System
 - disposal requirements, -xlii
- safety
 - internal components, safe to touch, -xxxii, -xxxiv
 - location of labels, -xvii
 - precautions, -xxxi
- saturation
 - adjusting, 9-7
- Saturation image parameter, D-8
 - guidelines for selecting setting, 9-8
 - setting in Macintosh PostScript, 6-23
 - setting in Windows PostScript, 6-7
- scaling algorithms, 1-5
- Scaling image parameter, D-9
 - setting in Macintosh PostScript, 6-23
 - setting in Windows PostScript, 6-7
- scratches
 - on imager basement, 2-6, 10-19
 - on sheet, 12-7
- scroll indicator in menus, 3-14
- selector arrow in menus, 3-14
- serial number
 - viewing, 12-29
 - where found, 12-30
- serial number label, -xxv
- service login
 - changing password, 2-20
- settings
 - print jobs, defaults, 8-1 to 8-8
- SGL image format, 1-4
- Sharp scaling filters, D-10
- Sheet Coverage parameter
 - setting in Macintosh PostScript, 6-22
 - setting in Windows PostScript, 6-8
- sheet jams
 - clearing, 12-14 to 12-21
 - troubleshooting, 12-6
- Sheet Layout parameter
 - setting in Macintosh PostScript, 6-21
 - setting in Windows PostScript, 6-6
- sheet parameters
 - Background, D-3
 - Border Fill, D-3
 - Captions, D-3
 - changing defaults, 8-5 to 8-6
 - Coverage, D-3
 - Dmax, D-4
 - Dmin, D-4
 - Film View, D-4
 - Image Warnings, D-5
 - LUT, D-5
- sheet settings, 1-5
- sheets
 - path through imager, 12-15
- shipping damage, 12-2
- shipping the imager, 2-26
- simple network
 - with Ethernet crossover cable, 2-13
 - with Ethernet hub, 2-12
- Skip Blank Pages parameter
 - setting in Macintosh PostScript, 6-22
 - setting in Windows PostScript, 6-7
- Smart Card, 1-6
 - panel door, 2-3, 2-21
 - swapping with another imager, 2-25
- software
 - updating, 1-6
- specifications, B-1 to B-6
- square brackets in menus, 3-20, 3-21
- startup
 - troubleshooting, 12-2

- status
 - cassette-related messages, 3-5, 12-12
 - color ribbon indicator, 3-6, 12-13
 - printing Status test print, 2-18
- status information
 - on Imager Status test print, 12-2
- Status screen
 - description, 3-4, 3-13
 - returning to from menus, 3-21
- Status test print, 12-2
 - printing, 2-18
- Status window
 - Alert messages, 3-12
 - description, 3-4, 3-13
 - Fault messages, 3-12
- Stuffit application, 12-32
- subnet mask, 2-13
- Suitable Environments, -xxviii
- supply cassettes, *see* cassettes
- supply slots, 4-2
 - status, 4-3
- Supply window, description, 3-4, 3-13
- Surge, -xxx
- swap imager, 2-25
- system Job Settings files, C-1 to C-3

T

- tar command, UNIX and Linux, 12-32
- TCP port number, 5-4
- technical support, 12-30
- television interference, -xxvii
- temperature warnings, -xxiii
- test print
 - Imager Status, 12-2
 - printing, 2-18
- testing network printing, 2-19
- TGA image format, 1-4
- thermal print head
 - calibration, 11-1
 - calibration schedule, 10-2
 - cleaning procedure, 10-3 to 10-7
 - cleaning schedule, 10-1
- TIFF image format, 1-4
- troubleshooting, 12-1 to 12-32
 - cassettes, 12-9
 - color ribbon, 12-9
 - image quality, 12-7

- miscellaneous, 12-11
- print jobs, 12-2
- sheet jams, 12-6
- startup, 12-2
- turning off the imager, 3-7
- turning on the imager, 3-3

U

- UNIX
 - compress command, 12-32
 - gzip application, 12-32
 - tar command, 12-32
- unshielded twisted pair (UTP) cable, 2-8
- updating software, 1-6
- UPS (uninterruptible power supply), 2-5
- UPS connector, 3-2
- USB flash drive port
 - uses, -xli, 1-6
- USB flash drives, -xli
- use of the imager, indications for, -xliii
- User's Manual, purpose, -xv

V

- viewing images, guidelines, 9-2
- Voltage Dips, -xxx
- Voltage Fluctuations and Flicker, -xxix
- Voltage Interruptions, -xxx
- voltage warnings, -xviii

W

- WAN, *see* wide area networks
- warnings
 - laser, -xxi
 - temperature, -xxiii
 - voltage, -xviii
- WEEE (Waste Electrical and Electronic Equipment)
 - disposal directive, -xliii
- wide area networks (WAN), 2-12
- Windows
 - PKZIP compression format, 12-32
- Windows applications
 - changing PostScript parameters, 6-4 to 6-16

PostScript printing from, 6-4 to 6-16
printing from, 1-3

X

XWD image format, 1-4

Z

Zip disks, -xli
 saving configuration settings to, 2-20
Zip drive
 and Smart Card panel door, 2-21
 uses, -xli, 1-6

